



Grid-tied PV String Inverter

SUN-70K-G03

SUN-75K-G03

SUN-80K-G03

SUN-90K-G03

SUN-100K-G03

SUN-110K-G03

User Manual

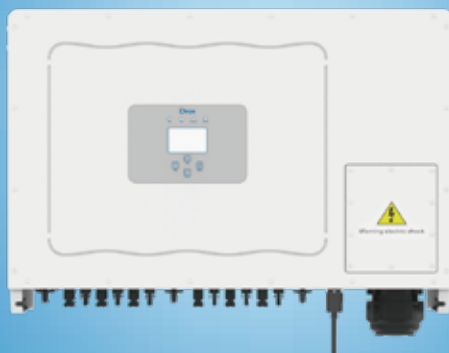

Contents

1. Introduction	- 1 -
1.1 Appearance introduction	- 1 -
1.2 Parts list	- 2 -
2. Safety warnings and instructions	- 3 -
2.1 Safety signs	- 3 -
2.2 Safety Guide	- 3 -
2.3 Notes for using	- 4 -
3. Operation interface	- 5 -
3.1 Interface view	- 5 -
3.2 Status indicator	- 5 -
3.3 buttons	- 6 -
3.4 LCD display	- 6 -
4. Product Installation	- 7 -
4.1 Select installation location	- 7 -
4.2 Recommended place	- 9 -
4.3 Installation of inverter	- 10 -
5. Electrical connection	- 11 -
5.1 DC input terminal connection	- 11 -
5.2 AC input terminal connection	- 13 -
5.3 Connection of the ground line	- 16 -
5.4 Inverter monitoring connection	- 16 -
6. Start up and shut off	- 18 -
6.1 Start up the inverter	- 18 -
6.2 Shut off the inverter	- 18 -
7. Zero export function via SUN limiter	- 19 -
7.1 SUN Limiter function wiring diagram	- 19 -
7.2 Connect the SUN limiter to inverter	- 20 -
7.3 Debugging SUN Limiter	- 23 -
7.4 Zero-export function (Option)	- 24 -
8. General Operation	- 26 -
8.1 The initial interface	- 26 -
8.2 Statistics information	- 29 -
8.3 Fault Record	- 31 -
8.4 ON/OFF setting	- 32 -
8.5 Parameter setting	- 33 -
9. Repair and Maintenance	- 38 -
10. Error information and processing	- 38 -
10.1 Error code	- 38 -
11. Specifications	- 43 -

About This Manual

The manual mainly describes the product information, guidelines for installation, operation and maintenance. The manual cannot include complete information about the photovoltaic (PV) system.

How to Use This Manual

Read the manual and other related documents before performing any operation on the inverter. Documents must be stored carefully and be available at all times. **Contents may be periodically updated or revised due to product development. The information in this manual is subject to change without notice.** The latest manual can be acquired via service@deye.com.cn

1. Introduction

1.1 Appearance Introduction

On-grid inverter can convert solar panel DC power into AC power which can directly input to the grid. Its appearance is shown below. These models contain SUN-70K-G03, SUN-75K-G03, SUN-80K-G03, SUN-90K-G03, SUN-100K-G03, SUN-110K-G03.

The following is collectively referred to as “inverter”.

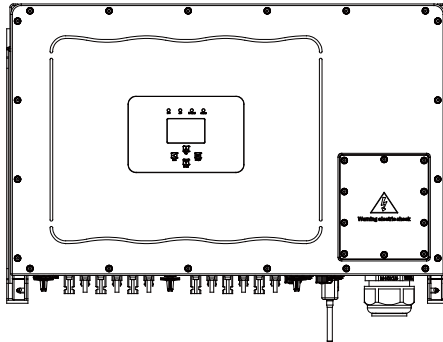

Pic 1.1 Front view

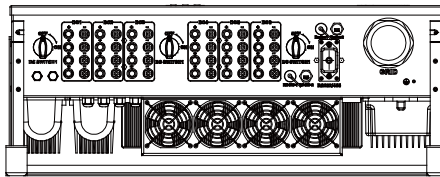

Pic 1.2 Bottom view

1.2 Parts list

Please check the following table, to see whether all the parts are included in the package :

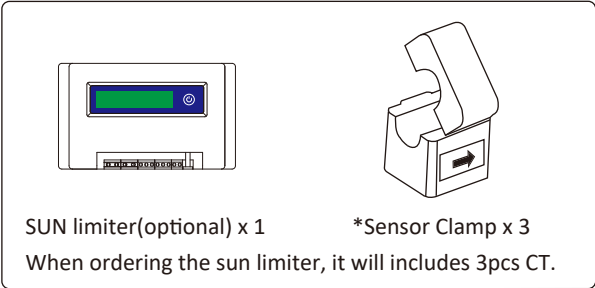
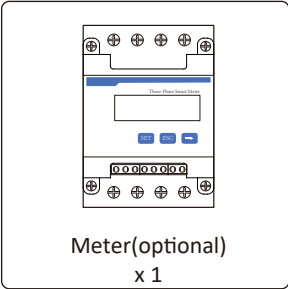
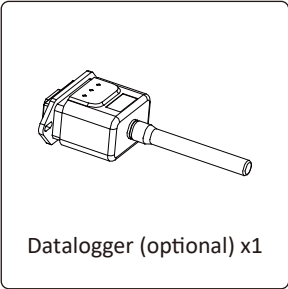
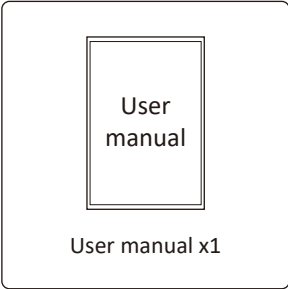
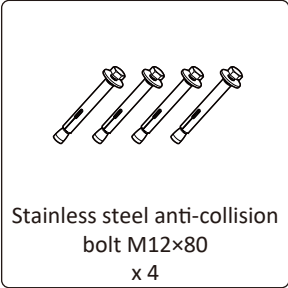
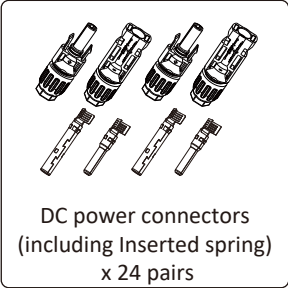
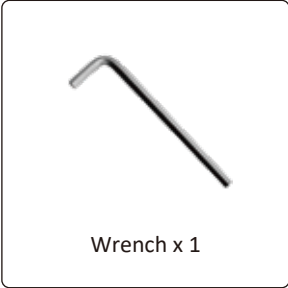
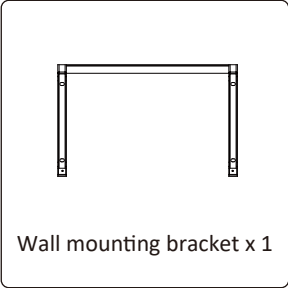
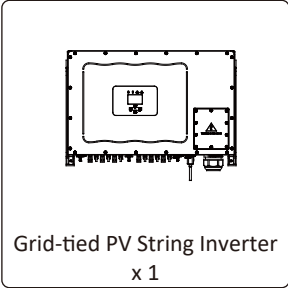

2. Safety warnings and instructions

Improper use may result in potential electric shock hazards or burns. This manual contains important instructions that should be followed during installation and maintenance. Please read these instructions carefully before use and keep them for future reference.

2.1 Safety Symbols

Safety symbols used in this manual, which highlight potential safety risks and important safety information, are listed as follows:



Warning:

Warning symbol indicates important safety instructions, which if not correctly followed, could result in serious injury or death.



Shock Hazard:

Caution, risk of electric shock symbol indicates important safety instructions, which if not correctly followed, could result in electric shock.



Safety Hint:

Note symbol indicates important safety instructions, which if not correctly followed, could result in some damage or the destruction of the inverter.



High Temperature Hazard:

Caution, hot surface symbol indicates safety instructions, which if not correctly followed, could result in burns.

2.2 Safety instructions



Warning:

Electrical installation of the inverter must conform to the safety operation rules of the country or local area.



Warning:

Inverter adopts non-isolated topology structure, hence must insure DC input and AC output are electrical isolated before operating the inverter. Strictly prohibit grounding the positive and negative poles of the PV string. Otherwise it will damage the inverter.



Shock Hazard:

Prohibit disassembling inverter case, there existing shock hazard, which may cause serious injury or death, please ask qualified person to repair.



Shock Hazard:

When PV module is exposed to sunlight, the output will generate DC voltage. Prohibit touching to avoid shock hazard.



Shock Hazard:

While disconnect the input and output of the inverter for maintenance, please waits for at least 5 mins until the inverter discharge the remnant electricity.



High Temperature Hazard:

Local temperature of inverter may exceed 80 °C while under operating. Please do not touch the inverter case.

2.3 Notes for using

The three phase string power inverter is designed and tested under related safety regulations. It can ensure the personal safety of the user. But as a electric device, it may cause shock or injury by incorrect operation. Please operate the unit under below requirements:

1. Inverter should be installed and maintained by qualified person under local standard regulations.
2. Must disconnect the AC side first, then disconnect DC side while doing installation and maintenance, after that, please wait at least 5 mins to avoid getting shocked.
3. Local temperature of the inverter may exceed 60 °C while under operating. Do not touch to avoid getting injured.
4. All electrical installation must be in accordance with local electrical standards, and achieved permission of local power company.
5. Please take appropriate anti-static measure.
6. Please install where children can not touch.

3. Operation Interface

3.1 Interface View

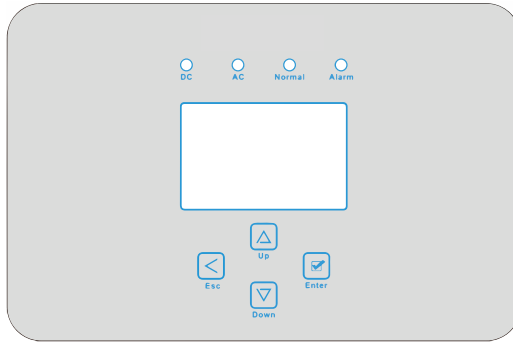

Pic 3.1 Front panel display

3.2 Status Indicator

The inverter panel has 4 indicators, the left one is dc output indicators, green indicates normal DC input. Beside is the AC indicator, green indicating normal ac connection. Beside the AC indicator is the operating indicator, green indicating normal output. The right indicator is alarm. red indicates alarming.

Indicator	status	Explanation
● DC	on	Inverter detects DC input
	off	Low DC input voltage
● AC	on	Grid Connected
	off	Grid Unavailable
● NORMAL	on	Under normal operating
	off	Stop operating
● ALARM	on	Detected faults or report faults
	off	Under normal operating

Table 3.1 Status indicator lights

3.3 Buttons

There are four buttons on the inverter panel: Above is Up and increase button (UP), Below is down and decrease button (DOWN), Left is ESC button (ESC), Right is Enter button (ENTER). Achieving below functions by the four buttons:

- Page turning (use UP and DOWN button)
- Modify adjustable parameters (use ESC and ENTER button)

3.4 LCD Display

Three phase string inverter use 256*128 dot formation display, Display below content:

- Inverter operation status and information;
- Operating information;
- Warning message and malfunction display.

4. Product installation

4.1 Select installation location

To select a location for the inverter, the following criteria should be considered:

WARNING: Risk of fire

- Do not install the inverter in areas containing highly flammable materials or gases.
- Do not install the inverter in potentially explosive atmospheres.
- Do not install in small closed spaces where air can not circulate freely. To avoid overheating, always make sure the flow of air around the inverter is not blocked.
- Exposure to direct sunlight will increase the operational temperature of the inverter and may cause output power limiting. It is recommended that inverter installed to avoid direct sunlight or raining.
- To avoid overheating ambient air temperature must be considered when choosing the inverter installation location. It is recommended that using a sun shade minimizing direct sunlight when the ambient air temperature around the unit exceeds 100°F/40 C .

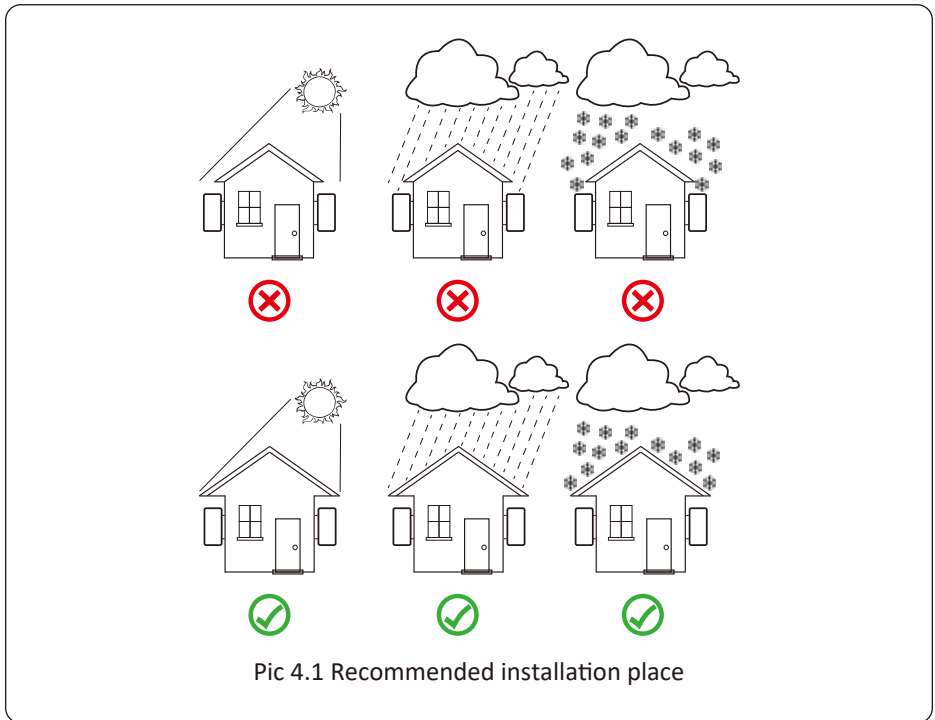

- Install on a wall or strong structure capable of bearing the weight.
- Install vertically with a maximum incline of $\pm 15^\circ$. If the mounted inverter is tilted to an angle greater than the maximum noted, heat dissipation can be inhibited, and may result in less than expected output power.
- If install more than one inverter, must leave at least 500mm gap between each inverter. And each inverter must be at least 500mm above and below. And must install the inverter at the place where children cannot touch. Please see picture 4.3.
- Consider whether the installation environment is helpful to see the inverter LCD display and indicator status clearly.
- Must offer a ventilate environment if inverter installed in the airtight house.



Safety Hint:

Do not place or store any items next to the inverter.

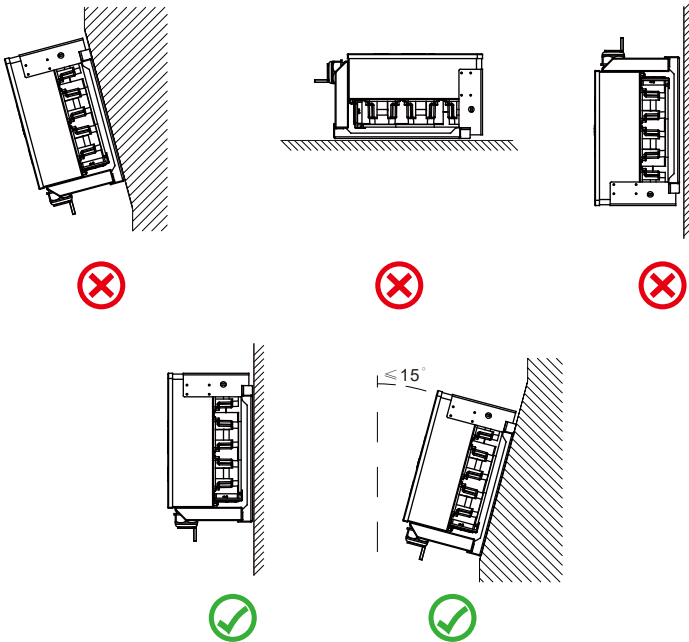

Pic 4.2 Installation Angle

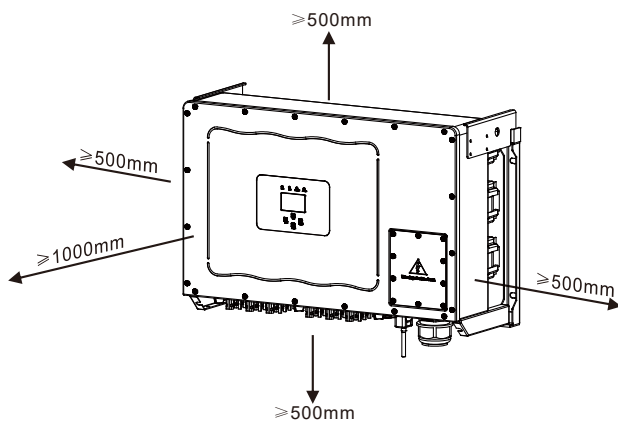

Pic 4.3 Installation Gap

4.2 Inverter of inverter

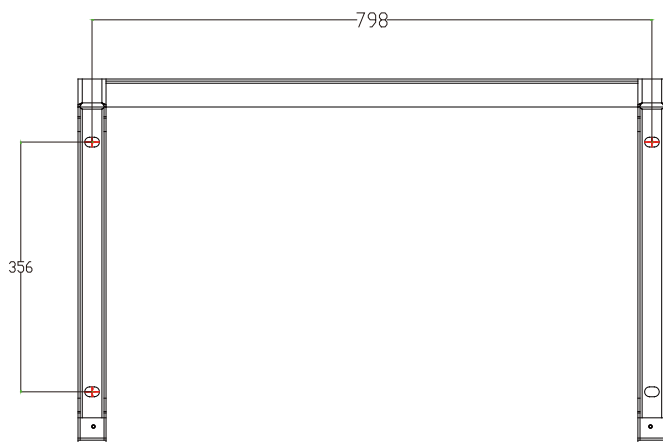

Pic 4.4 Mounting bracket dimensions

4.3 Inverter Installation

The inverter should be mounted in a vertical position. The steps of mounting are as follows

1. For brick walls, the position of the holes should be suitable for the expansion bolts.
2. Make sure the bracket is horizontal and the mounting holes are in the correct points. Drilling the holes on the wall according the marks.
3. Using the expansion bolts to fix the bracket to the wall.

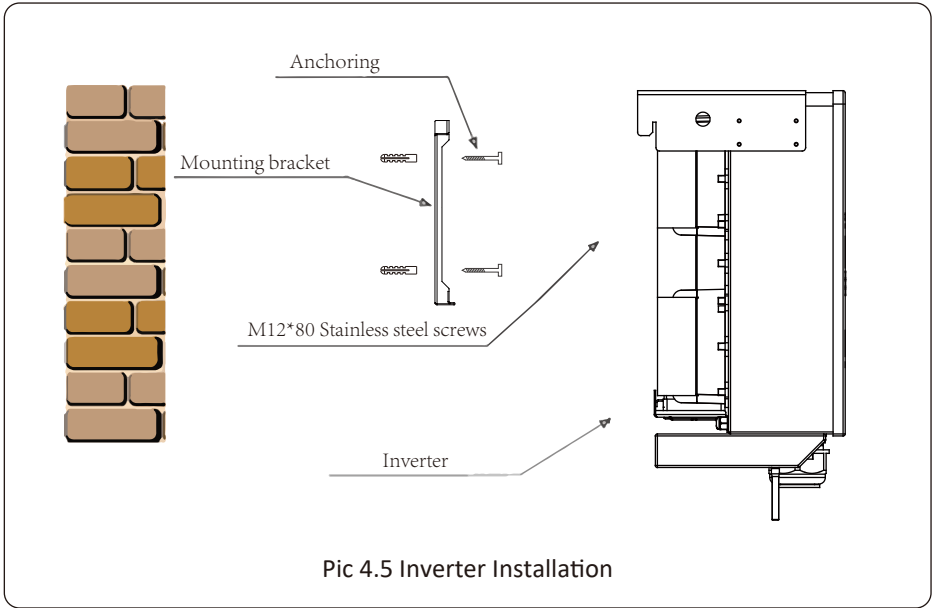

Pic 4.5 Inverter Installation

5 Electrical Connection

5.1 DC input terminal connection

1. Switch the Grid Supply Main Switch(AC)OFF.
2. Switch the DC Isolator OFF.
3. Assemble PV input connector to the inverter.



Safety Hint:

Please don't connect PV array positive or negative pole to the ground, it could cause serious damages to the inverter.



Safety Hint:

Before connection, please make sure the polarity of the output voltage of PV array matches the "DC+" and "DC-" symbols.



Safety Hint:

Before connecting inverter, please make sure the PV array open circuit voltage is within the 1000V of the inverter.

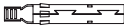
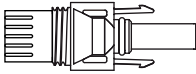

Pic 5.1 DC+connector (MC4)

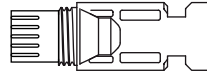

Pic 5.2 DC-connector (MC4)



Safety Hint:

Please use approved DC cable for PV system.

Cable type	Cross section (mm ²)	
	Range	Recommended value
Industry generic PV cable (model: PV1-F)	4.0~6.0 (12~10AWG)	4.0(12AWG)

Table 5.1 DC Cable Specifications

The steps to assemble the DC connectors are listed as follows:

a) Strip off the DC wire about 7mm, disassemble the connector cap nut (see picture 5.3).

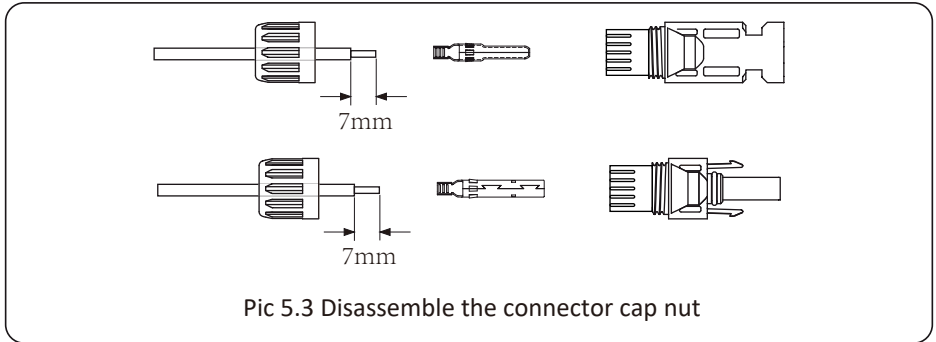

b) Crimping metal terminals with crimping pliers as shown in picture 5.4.



c) Insert the contact pin to the top part of the connector and screw up the cap nut to the top part of the connector. (as shown in picture 5.5).

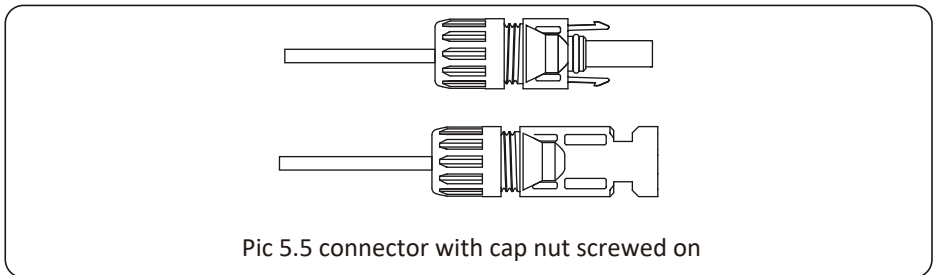

d) Finally insert the DC connector into the positive and negative input of the inverter, shown as picture 5.6

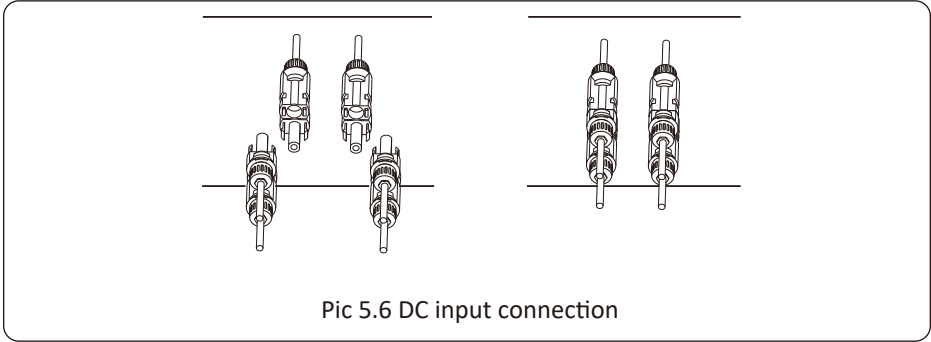

Warning:

Sunlight shines on the panel will generate voltage, high voltage in series may cause danger to life. Therefore, before connecting the DC input line, the solar panel needs to be blocked by the opaque material and the DC switch should be 'OFF', otherwise, the high voltage of the inverter may lead to life-threatening conditions.

5.2 AC input terminal connection

AC connection can use 16-25mm, 105 °C cable, please make sure the resistance of cable is lower than 1.5ohm. If the cable is longer than 20m, it's recommended to use 20-25mm cables.



Warning:

The AC cable line L1 is connected to socket 1; L2 is connected to socket 2; L3 is connected to socket 3, the PE line is connected to the earth , the N wire is connected to the socket of N.

Cable specifications		Copper core cable
Conductor cross-sectional area (mm ²)	Recommended range	50-70

Table 5.2 Recommended cable specifications

AC wire production method is the same as that of 5.2.1.

AC wire installation method:

1) Remove the 8 fixing screws on the AC junction box of the inverter as shown in Pic 5.7.

After removing the junction box, you can see the terminals of the inverter. The default is 5 digits as shown in Pic 5.8.

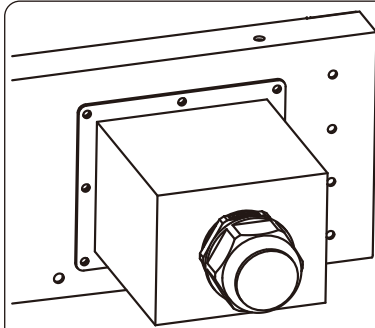

Pic 5.7 AC junction box

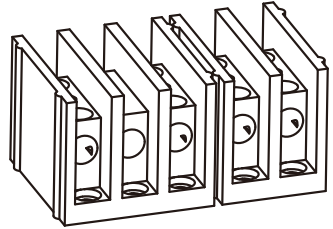

Pic 5.8 AC terminal

2) Connect the cable through the junction box, waterproof jacket, and insert into the terminal (The picture shows the connection mode of three phase lines connected to the junction box, ground wire screwed on the inverter shell) Pic5.9, and use hexagon screwdriver to presses the wiring harness to the connect terminal as shown in Pic5.10.

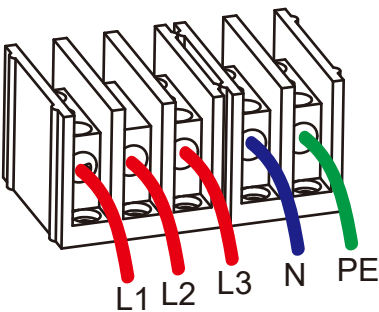

Pic 5.9 AC cable connected to the terminal

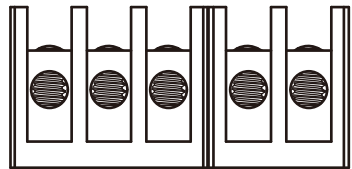

Pic 5.10 Tightening the AC connection cable

3) Screw the AC connection cover back to the shell and tighten all the screws to tighten the waterproof protection connector, as shown in Pic 5.11

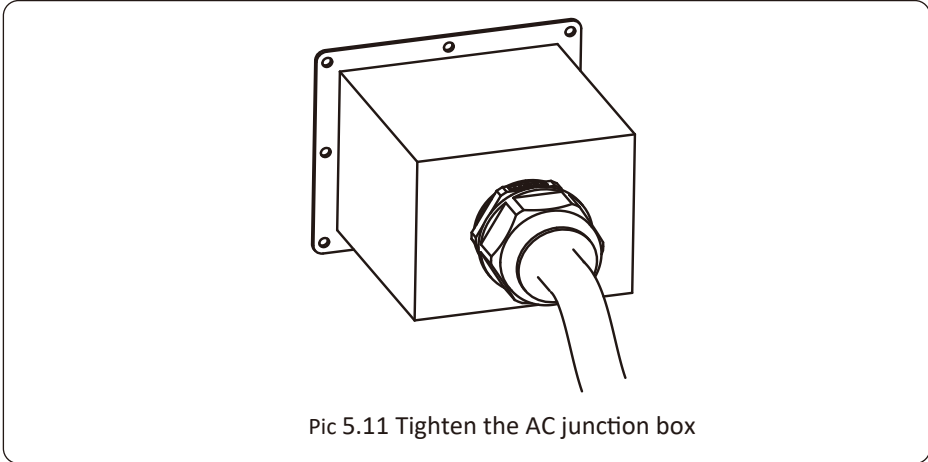

Pic 5.11 Tighten the AC junction box

5.2.3 Recommended current protector specifications

Inverter	Rated voltage	Rated output power (KW)	Current protection device (A)
SUN-70K-G03	400	70	150
SUN-75K-G03	400	75	150
SUN-80K-G03	400	80	150
SUN-90K-G03	400	90	150
SUN-100K-G03	400	100	150
SUN-110K-G03	400	110	150

Table 5.3 Recommended current protector specifications

5.3 Connection of the ground line

Good grounded is important for resist the surge voltage shock and improve EMI's performance. So before the connection of AC, DC, communication connections, inverter needs to ground first. For a single system, just ground the PE cable; For multiple machine systems, all PE cables of the inverter need to be connected to the same grounding copper platoon to ensure the equipotent connection. The installation of the shell ground wire is shown as.

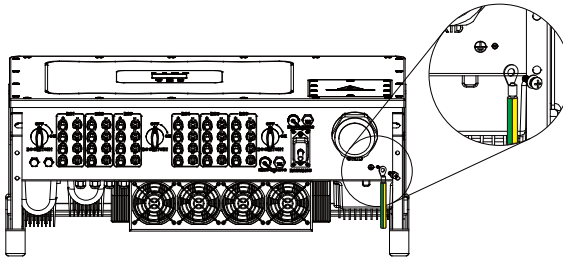

Pic 5.12 The installation of the shell ground wire



Warning:

Inverter has built-in leakage current detection circuit, If an external leakage current protection device is connected, its operating current must be greater than 300 mA or higher, otherwise inverter may not work properly.

5.4 Inverter monitoring connection

Inverter has the function of wireless remote monitoring inverter. The inverter has Wifi function and Wifi Plug in the accessories is used to realize the connection between the inverter and the network. The operation, installation, networking, APP download are detailed in the WIFI PLUG instructions. Figure 5.13 is the Internet monitoring solution.

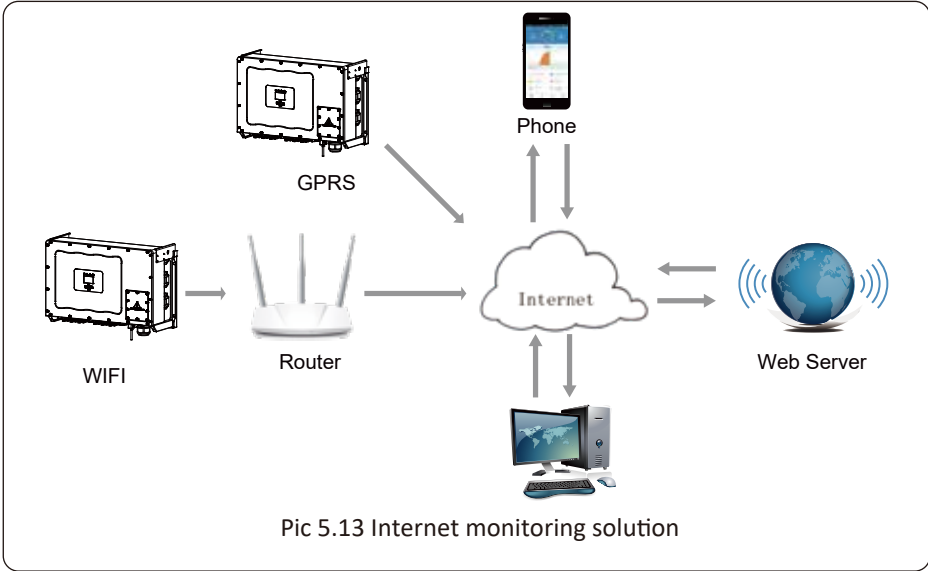

Pic 5.13 Internet monitoring solution

5.4.1 Installation of datalogger

When the inverter is out of the factory, the location of the installation of datalogger is sealed by a sealed plate as shown in Picture 5.14. When installing the datalogger, remove the sealing plate, replace it with the sealing plate with square hole in the accessories, and tighten the screws. Insert the datalogger into the interface and fix it with a screw. The configuration of the datalogger needs to be performed after various electrical connections have been completed and the inverter DC power on. When the inverter is on the DC power, it is determined whether the datalogger is normally electrified (The LED light shines out of the shell).

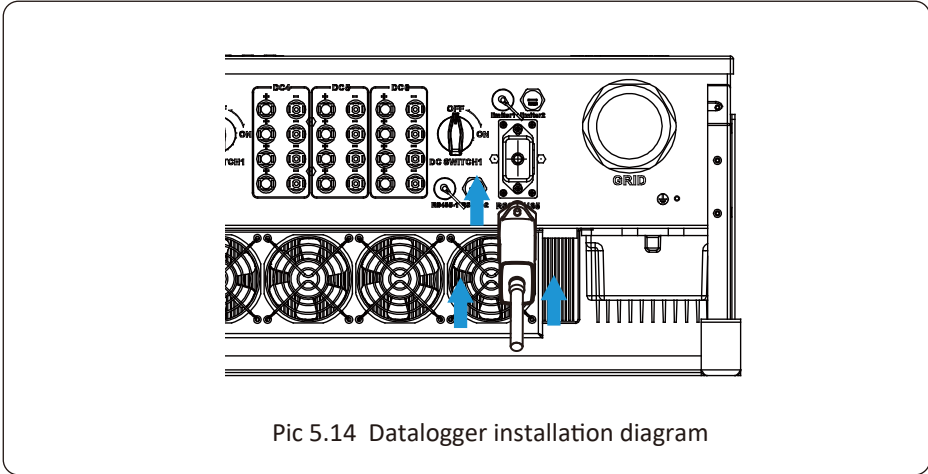

Pic 5.14 Datalogger installation diagram

5.4.2 Configuration of datalogger

For the configuration of datalogger, please refer to illustrations of the datalogger.

6. Start up and Shut off

Ensure that the inverter meets the following conditions before starting the inverter, otherwise it may cause fire or damage to the inverter without quality assurance, at the same time the situation on our company does not undertake any responsibility. At the same time, to optimize the system configuration, it is recommended that the two inputs be connected to the same number of PV modules.

- a). The maximum open voltage of each set of PV modules shall not exceed 1000Vdc under any conditions.
- b). Each input of the inverter better use the same type of PV module in series.
- c). Total output power of pv shall not exceed the maximum input power of inverter, each PV modules shall not exceed the rated power of each channel.

6.1 Start up the inverter

When start up the inverter, should follow below steps:

1. First switch on the AC breaker.
2. Turn on the DC switch of the PV module, and if the panel provides sufficient starting voltage and power, the inverter will start.
3. When the AC voltage and DC voltage are normal, the inverter start-up is ready to begin. The inverter will first check the internal parameters and the grid parameters, while the liquid crystal will show that the inverter is self-checking.
4. If the parameter is within acceptable range, the inverter will generate energy. NORMAL indicator light is on.

6.2 Shut off the inverter

Must follow below steps while Shutting down the inverter:

1. Switch off the AC breaker.
2. Wait for 30 seconds, turn off the dc switch (if any), or simply disconnect the dc input connector. The inverter will close the LCD and all led within two minutes.

7 Zero export function via SUN limiter

The inverter has external zero export function. This function is optional. It can collect counter-current power to control the output power of the inverter, so that the power of inverter and load can be offset, and the excess power will not be fed back to the grid. If you purchase the inverter with zero export function, an external zero export device (SUN limiter or energy meter) will be included in the package which is necessary for the function. The SUN limiter shows as Pic 7.1. You can see corresponding line mark next to the green interface. The green terminals on the left are the interface of three-phase AC line (L1, L2, L3) and N Line (N), and the right are the interface between three sets of current sensor and one set of control terminals. SUN limiter will collect voltage and current from these interfaces and send control signals to the inverter.

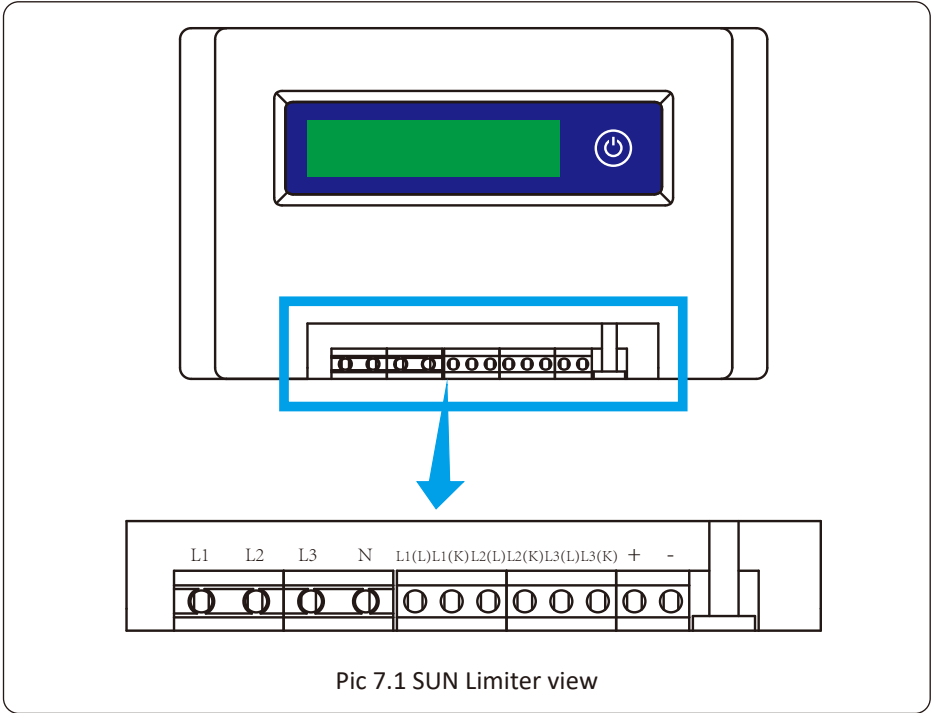

7.1 SUN Limiter function wiring diagram

When you are reading this, we believe that you have completed the connection according to the requirements of chapter 5, if you have been running your inverter, and you want to use the limiter function, please turn off AC and DC switch of the inverter, and wait for 5 minutes until the inverter completely discharged. In order to make it easier for you to use the limiter function, we have specifically given the wiring diagram, as shown in Picture 7.2, the yellow/green/red live line (L1, L2, L3) connected to the utility grid live line (U/V/W), blue line means the neutral line.

We recommend installing an AC switch between the inverter outlet and the utility grid, the specs of the AC switch is determined by the load capacity. The AC switch we recommend to connect to the inverter output refer to Table 5.2.

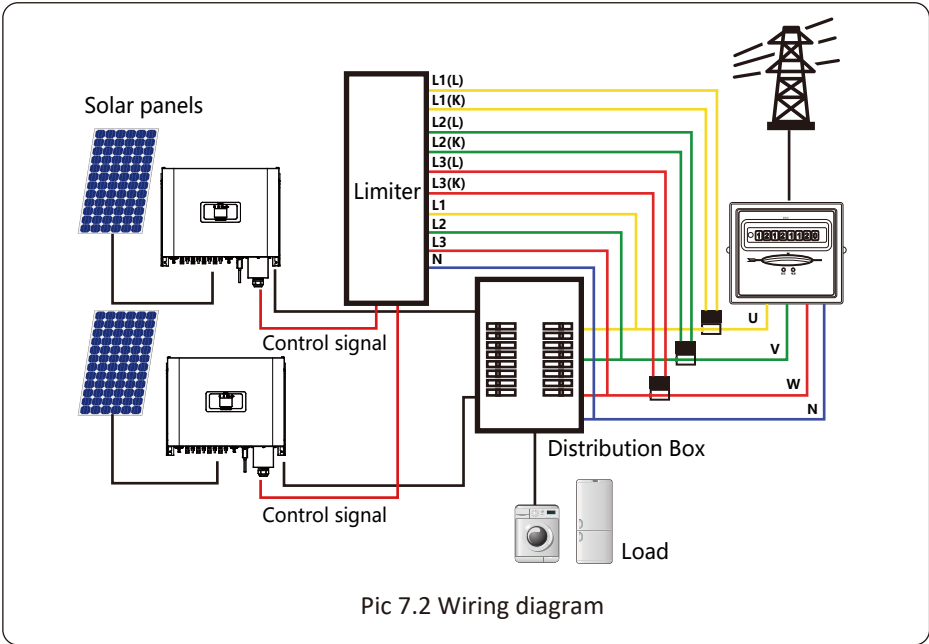

Pic 7.2 Wiring diagram

7.2 Connect the SUN limiter to inverter

The SUN limiter will measure the voltage and current of three phases separately, and this manual only introduces the installation steps of one phase, the other two phases are the same. The specific installation steps are as follows:

- (1) Connect SUN limiter to the grid. Connected to the grid is to measure the voltage of grid. Before connect to the grid, please turn off the switch to avoid the risk of electric shock. Choose one wire from the bottom of the three-phase DC switch. (any phase of U,V,W) to connect with L1 terminal, then tighten the line with a screwdriver.
- (2) Connect SUN limiter to clamp sensor. Clamp sensor can measure the current of the AC side, it should be connected to the front side of the load (domestic appliance ect.) to achieve this function. Only when the SUN limiter collects the voltage and current of the same phase can it judge the power of the phase. So the clamp sensor should be connected to the same phase as the before. Open the side buckle of the clamp sensor, then clamp the sensor to the AC line on the DC switch, the arrow direction on the sensor should towards that of the load. The clamp sensor has two lines (shown as below), and the white line corresponds to K terminal, black line corresponds to L terminal. Connect the white line to the L1(L) and L1(K) terminal refer to the line mark of the SUN limiter and tighten the line with screwdriver. This is the whole installation process of one phase.

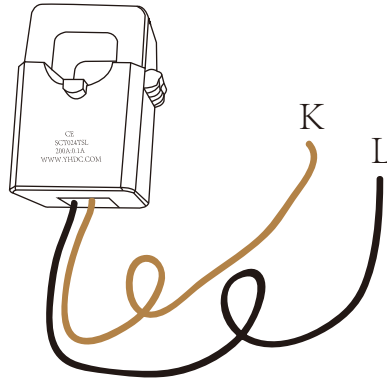

Pic 7.3 Clamp Sensor

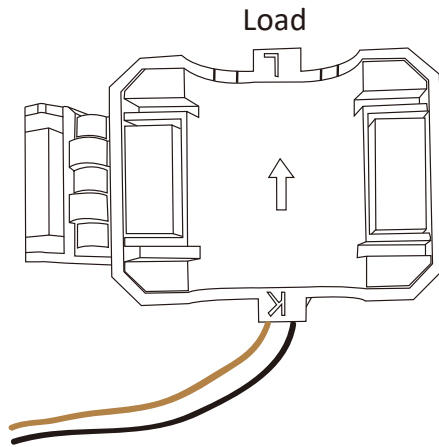

Pic 7.4 Clamp Sensor internal arrow

(3) After you finish the installation in process 1 and 2, connect the N line (N) to the N terminal of the limiter and tighten the line.

(4) Connect the control line. There are two numbers 1 and 2 on the interface of SUN limiter, and the same on the waterproof terminal of the inverter. Twist the waterproof terminal and connect the red line to number 1 and black line to number 2 shown as the picture. After that connect the terminal to the interface of the SUN limiter. The other side of the line should be connected to the control terminal.

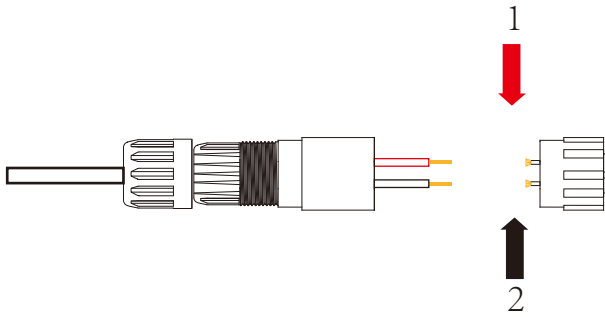

Pic 7.5 Waterproof terminal

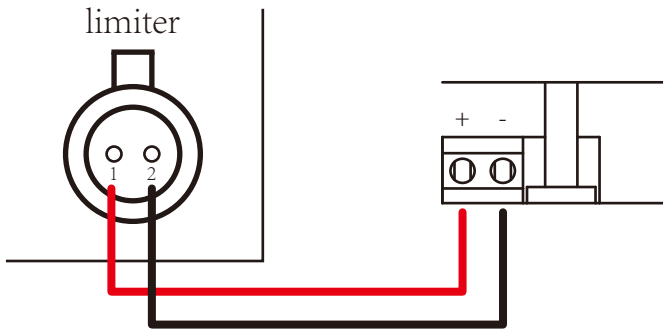

Pic 7.6 Connect SUN limiter to inverter

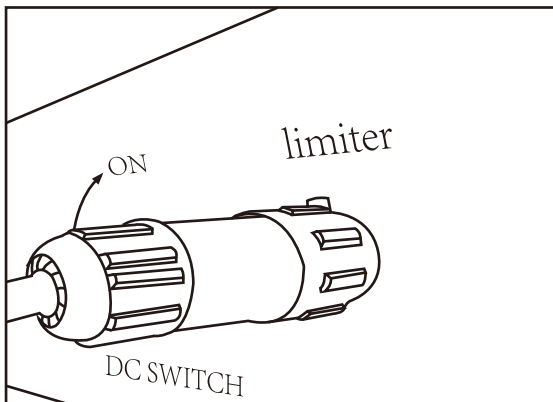

Pic 7.7 Connect terminal to inverter

7.3 Debugging SUN Limiter

Turn on the anti-backflow function of the inverter refer to the manual , then turn on the SUN limiter's power supply, next close the DC switch, and last turn on the inverter.

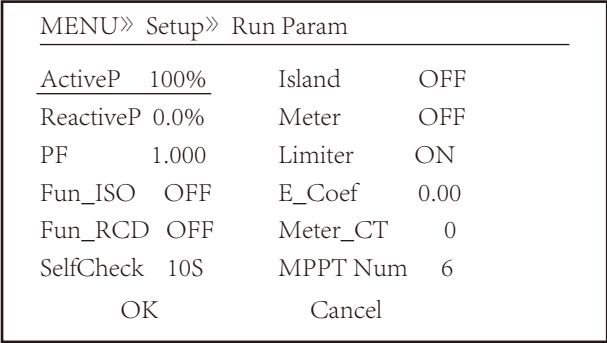

MENU» Setup» Run Param			
ActiveP	100%	Island	OFF
ReactiveP	0.0%	Meter	OFF
PF	1.000	Limiter	ON
Fun_ISO	OFF	E_Coef	0.00
Fun_RCD	OFF	Meter_CT	0
SelfCheck	10S	MPPT Num	6
OK		Cancel	

Pic 7.8 Zero-export function via SUN limiter setting interface

Press the button of the SUN limiter to the setting interface. Long press the button to switch the anti-backflow mode. SUN limiter has two anti-backflow modes, the minimum mode and the average mode. In the minimum mode, SUN limiter will control the power of the inverter according to the phase with the lowest power to ensure that no reverse current will occur in each phase. In average mode, SUN limiter controls the output of the inverter according to the average of the total power of the three-phase load, which may cause single backflow. The controller is produced in the minimum mode to ensure no anti-backflow happens to the customers.

7.4 Zero-export function (Option)

The string inverter supports zero-export function via Energy meter / SUN-Limiter. Based on continuously data communication, once the Limiter or energy meter detects power export to the grid, it will send the information to the inverter and then inverter can instruct the inverter to ramp down its active power according to match the load demand and achieve zero export. The Zero-export function is optional. If you buy the inverter with zero-export function via energy meter, energy meter will be included in the package which is necessary for zero-export function.

7.4.1 Zero-export function via energy meter

When you are reading this, we believe that you have completed the connection according to the requirements of chapter 5, if you have been running your inverter at this time, and you want to use the zero-export function, please turn off AC and DC switch of the inverter, and wait for 5 minutes until the inverter completely discharged. Please follow below Picture 7.9 to connect the energy meter.

For system wiring diagram, the red line refers to L line (L1,L2,L3,), the black line refers to the neutral line (N). Connecting energy meter RS485 cable to inverter's RS485 port. It's recommended to install an AC switch between the inverter and the utility grid, the specs of the AC switch are determined by the power of load.

If there is no integrated DC switch inside the inverter you purchased, we commend you to connect the DC switch. The voltage and current of the switch depend on the PV array you access.

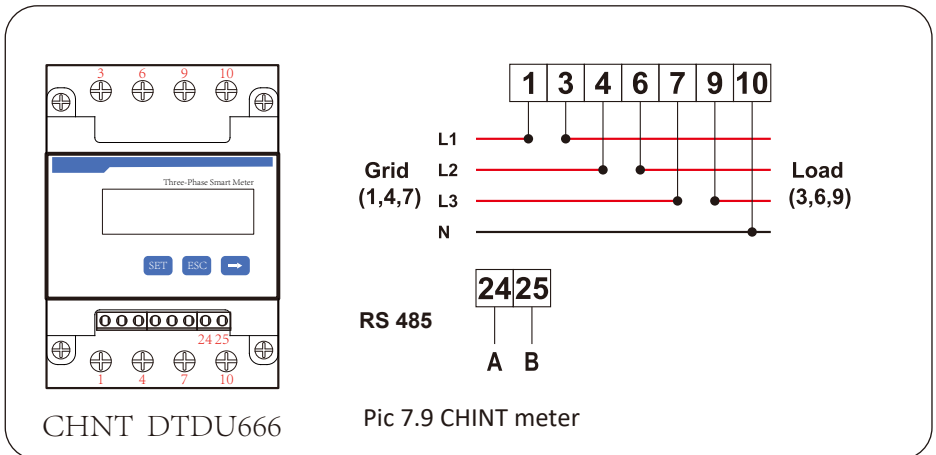

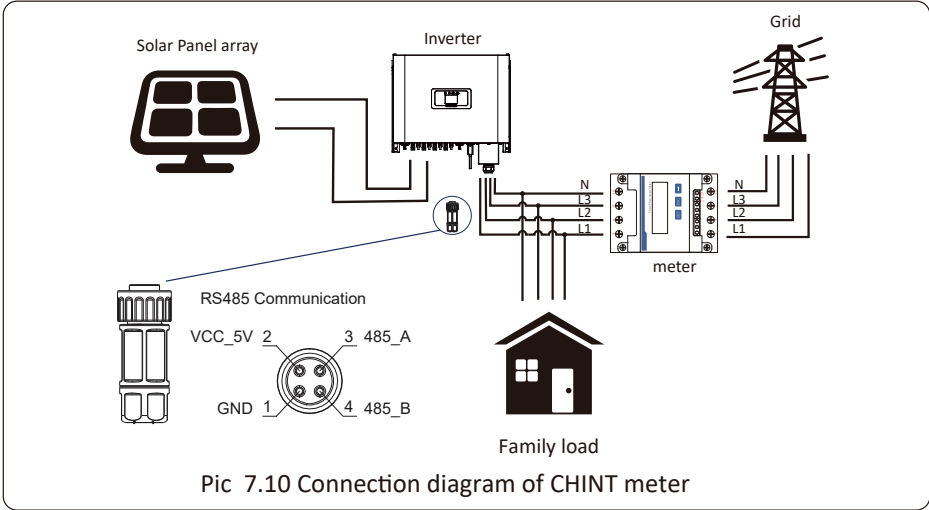

 **Warning:**
 Ensuring grid input cables connect 1/4/7/10 port of energy meter, and inverter AC output cables connect 3/6/9/10 port of energy meter when connecting.

7.4.2 Debugging energy meter

Turn on the anti-backflow function of the inverter refer to the manual, next close the DC switch, and last turn on the inverter.

MENU» Setup» Run Param			
ActiveP	100%	Island	OFF
ReactiveP	0.0%	Meter	ON
PF	1.000	Limiter	OFF
Fun_ISO	OFF	E_Coef	0.00
Fun_RCD	OFF	Meter_CT	0
SelfCheck	10S	MPPT Num	6
OK		Cancel	

Pic7.11 Zero-export function via energy meter

8. General Operation

During normal operation, the LCD shows the current status of the inverter, including the current power, total generation, a bar chart of power operation and inverter ID, etc. Press the Up key and the Down key to see the current DC voltage, DC current, AC voltage, AC current, inverter radiator temperature, software version number and Wifi connection state of the inverter.

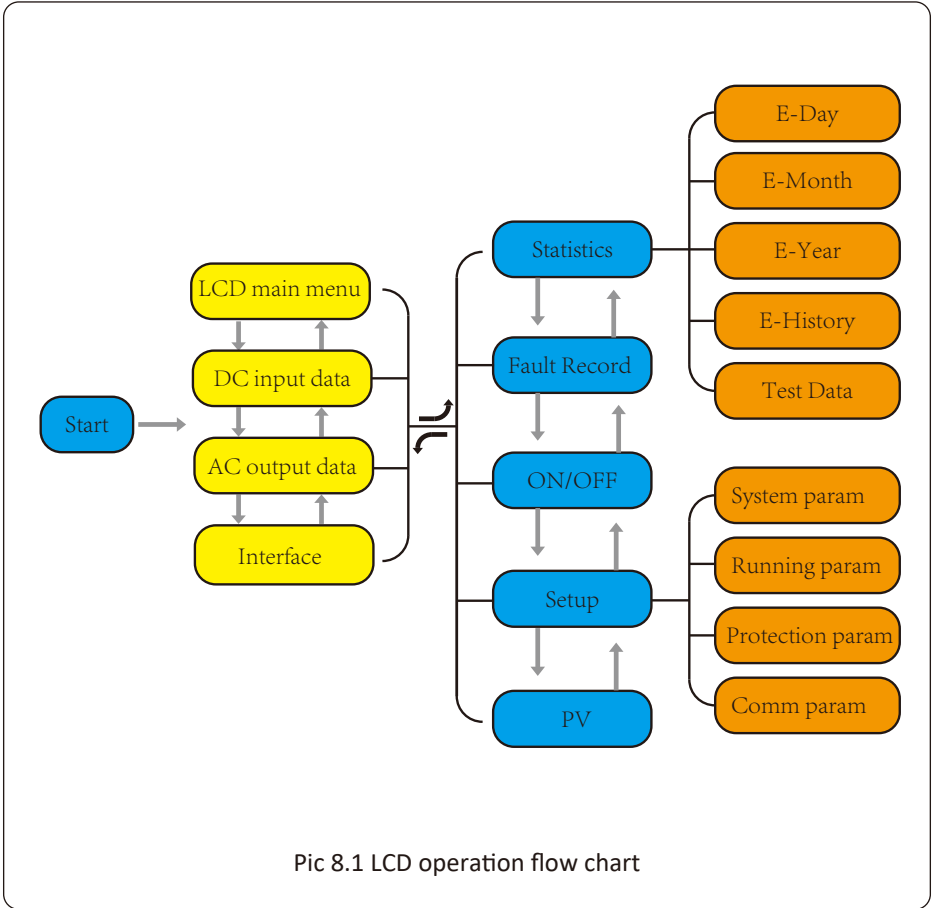

Pic 8.1 LCD operation flow chart

8.1 The initial interface

From the initial interface, you can check power, day power, total power, inverter ID , model and time.

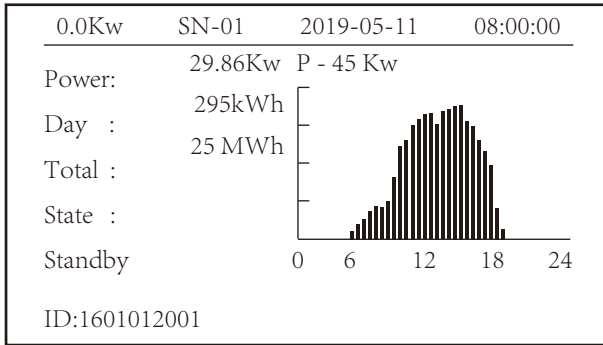

Pic 8.1 The initial interface

Press UP or Down you can check inverter DC voltage, DC current, AC voltage, AC current, inverter temperature, software version information.

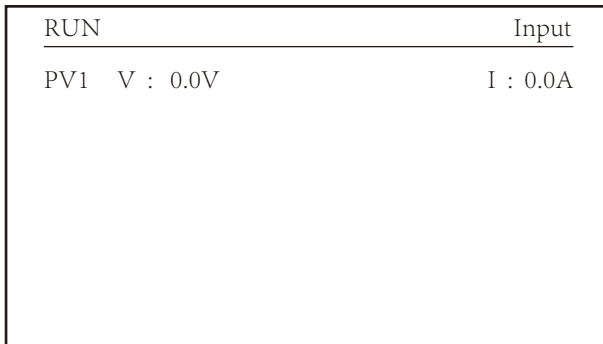

Pic 8.2 PV input and DC current information

You can check the PV information, the number of strings input, MPPT voltage and MPPT current.

RUN	Grid
Ua : 234.5V	Ia : 0.0A
Grid Freq : 50.00Hz	

Pic 8.3 AC running state information

You can check the three phase voltage, current, and grid frequency.

RUN	
Ver :	0166
Ver :	1860

Pic 8.4 Inverter firmware version

You can check the inverter LCD software Ver0166 and Control Software Version Ver1860. There are two black spot in the bottom right corner. The first flash means inverter is communicating with LCD. The second flash means LCD is communicating with wifi plug.

PARAMETR	Meter
	SN: 0
Meter Power:	0W
Load Power:	0W
Day	Total
ImpEp : 0.00kWh	0.00kWh
ExpEp : 0.00kWh	0.00kWh
LoadEp : 0.00kWh	0.00kWh

Pic 8.5 Meter power and load power

8.1.1 Main Menu

There are four submenu in the Main Menu.

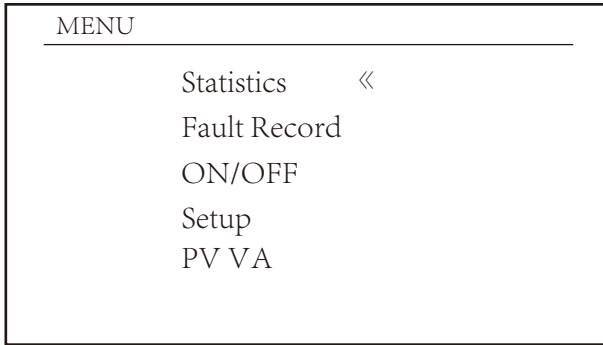

Pic 8.5 Main Menu

8.2 Statistics information

There are five submenu in the statistics.

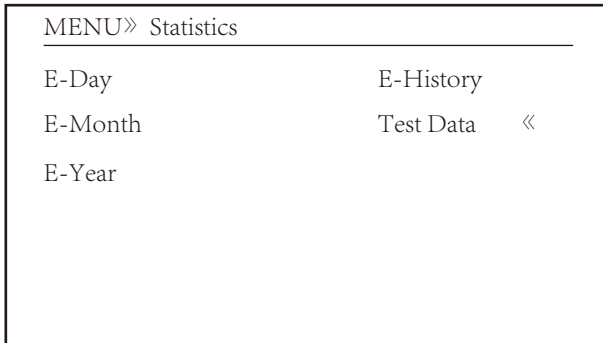

Pic 8.6 Statistics

Into each submenu through cursor.

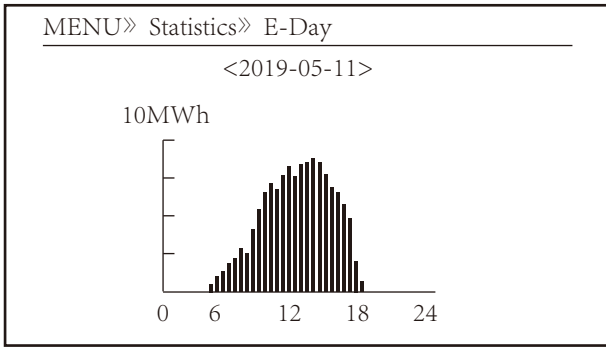

Pic 8.7 E-Day

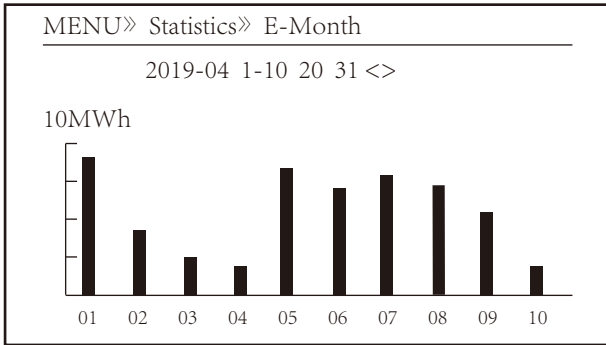

Pic 8.8 E-Month

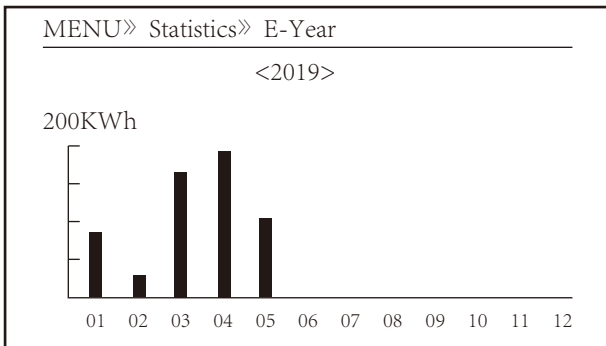

Pic 8.9 E-Year

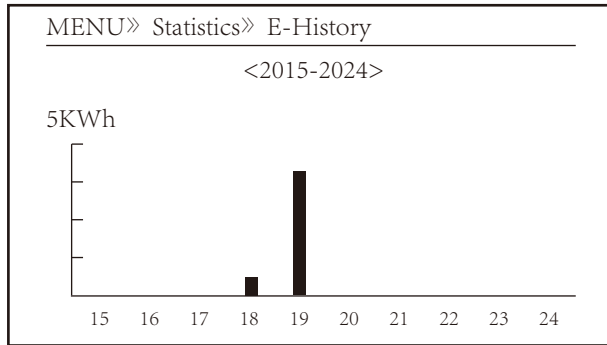

Pic 8.10 E-History

This information is for technician's reference.

PV1 :	19186	1k3 :	11126	ofC :	2057
PV2 :	19198	1k4 :	11140	137 :	2145
HV :	24362	1k5 :	16666	138 :	2248
GFD :	9119	1k6 :	2927	139 :	1497
DiL :	36	vHV :	24362	140 :	0
AVL :	-2	BSn :	12218		
126 :	287	ofA :	2065		
1k2 :	6	ofB :	2653		

Pic 8.11Test Data

8.3 Fault Record

Only can keep four fault record in the menu include time, customer can deal with it depends on the error code.

MENU» Fault Record	
Fault :	F352019-05-05 08:38
History :	1 F352019-05-05 08:37
	2 F352019-04-24 18:47
	3 F352019-04-24 17:54
	4 F352019-04-24 17:53

Pic 8.12 Fault Record

8.4 ON/OFF setting

MENU» ON/OFF	
Turn ON	
Turn OFF <<	

Pic 8.13 ON/OFF setting

Into each submenu through cursor.

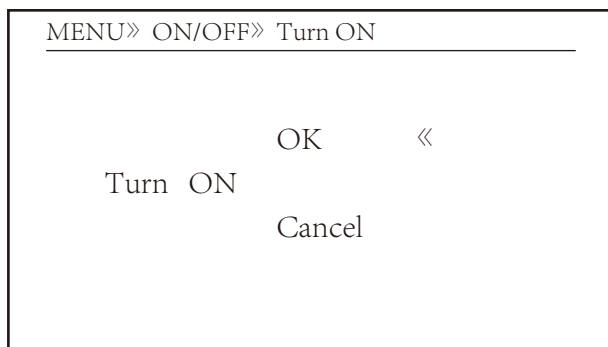

Pic 8.14 ON set

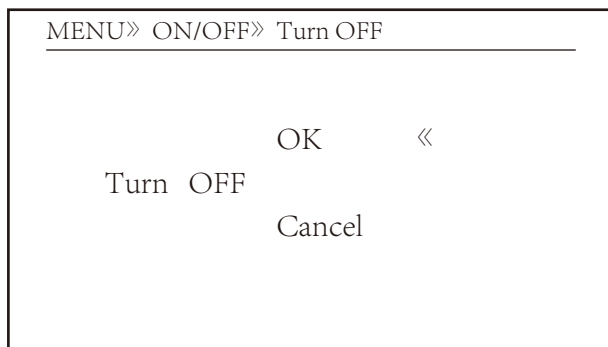

Pic 8.15 OFF set

8.5 Parameter setting

Setting includes system param, run param, protect param, comm.. param. All of these information for maintenance reference.

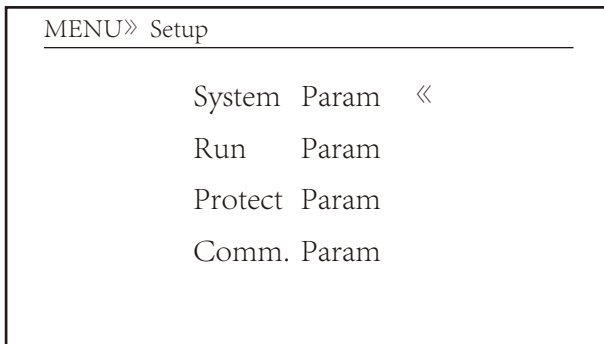

Pic 8.16 Setting

8.5.1 System Param

System Param includes time set, language set, display set and factory date reset.

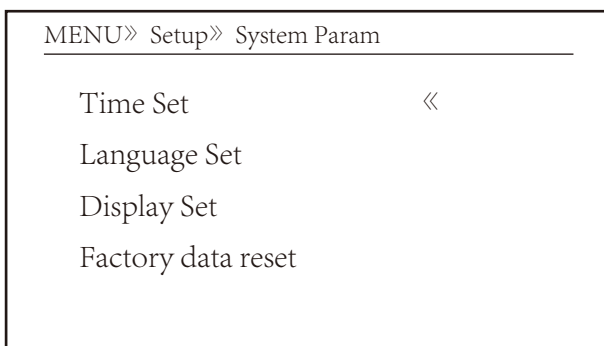

Pic 8.17 System Param

8.5.1.2 Time Set

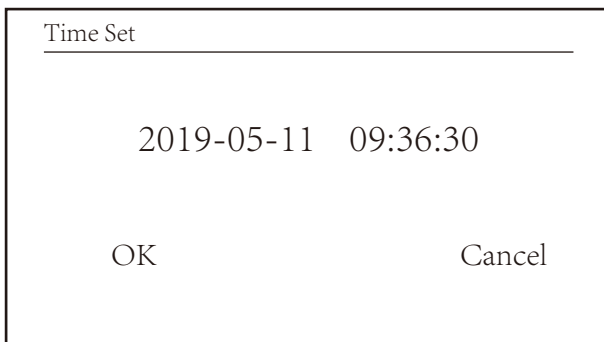

Pic 8.18 System Param

8.5.1.3 Language Set

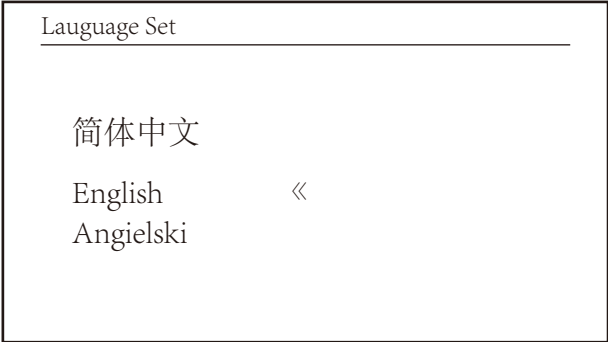

Pic 8.19 Language set

8.5.1.4 Display Set

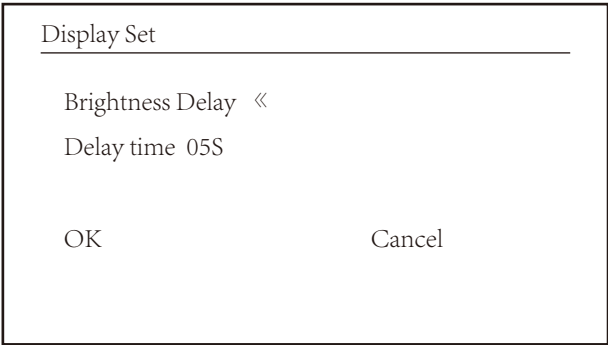

Pic 8.20 Display set

8.5.1.5 Factory data reset

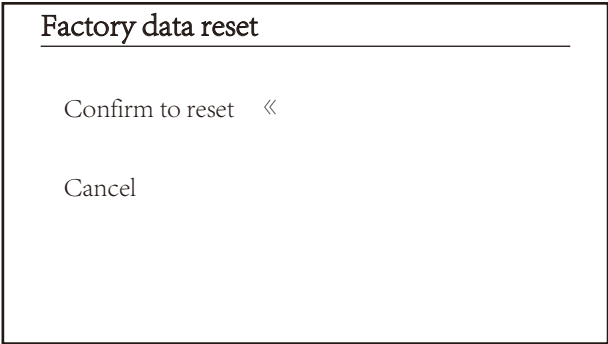

Pic 8.21 Factory data reset set

8.5.2 Running Param



Note:

Password required-- only for access-authorized engineer. Un-authorized access may avoid the warranty. The initial password is 1234.



Pic 8.22 Password

MENU» Setup» Run Param			
ActiveP	100%	Island	ON
ReactiveP	0.0%	Meter	OFF
PF	1.000	Limiter	OFF
Fun_ISO	ON	E_Coef	0.00
Fun_RCD	ON	Meter_CT	0
SelfCheck	10S	MPPT Num	6
	OK	Cancel	

Pic 8.23 Running Param



Note:

Engineer Only.

We will set the param depends on the safety requirements, so customers don't need to reset it. The password is same as 8.4 Running param

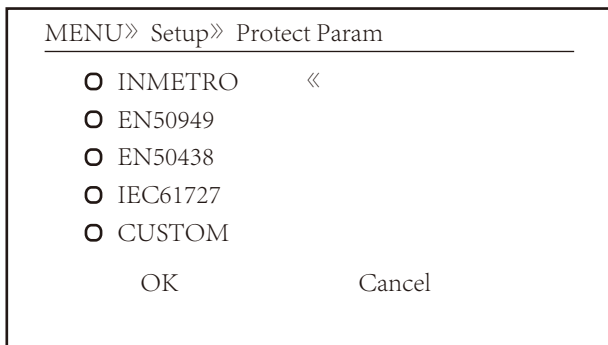

Pic 8.24 Protect Param



Note:
Engineer only.

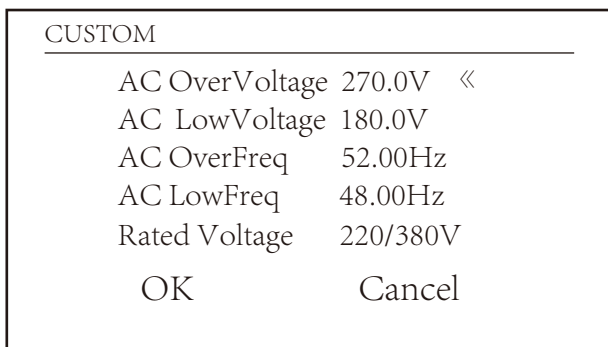

Pic 8.25 "CUSTOM"

8.5.4 Comm. Param

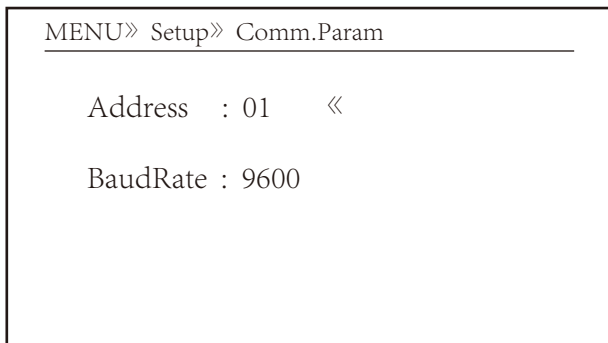

Pic 8.26 Communication param

9. Repair and Maintenance

String type inverter doesn't need regular maintenance. However, debris or dust will affect heat sink's thermal performance. It is better to clean it with a soft brush. If the surface is too dirty and affect the reading of LCD and LED lamp, you can use wet cloth to clean it up.



Warning:

When the device is running, the local temperature is too high and the touch can cause burns. Turn off the inverter and wait for it cooling, then you can clean and maintain.



Warning:

No solvent, abrasive materials or corrosive materials can be used for cleaning any parts of the inverter.

10. Error information and processing

Inverter has been designed in accordance with international grid tied standards for safety, and electromagnetic compatibility requirements. Before delivering to the customer the inverter has been subjected to several tests to ensure its optimal operation and reliability.

10.1 Error code

If there is any failure, the LCD screen will display an alarm message. In this case, the inverter may stop feeding energy into the grid. The alarm description and their corresponding alarm messages are listed Table 10.1.

Error code	Description	Ongrid - Three Phase
F01	DC input polarity reverse fault	Check the PV input polarity.
F02	DC insulation impedance permanent fault	Check the grounding cable of inverter.
F03	DC leakage current fault	Hardly appear the code. Never ever happened so far.
F04	Ground fault GFDI	Check the solar panel output connection.
F05	Read the memory error	Failure in reading memory (EEPROM). Restart the inverter if the fault still exists, contact your installer or Deye service.
F06	Write the memory error	Failure in writing memory (EEPROM). Restart the inverter if the fault still exists, contact your installer or Deye service.
F07	GFDI blown fuse	Hardly appear the code. Never ever happened so far.
F08	GFDI grounding touch failure	Hardly appear the code. Never ever happened so far.
F09	IGBT damaged by excessive drop voltage	Hardly appear the code. Never ever happened so far.
F10	Auxiliary switch power supply failure	1. It tells the DC 12V is not existed. 2. Restart the inverter, if the fault still exists, please contact your installer.
F11	AC main contactor errors	Hardly appear the code. Never ever happened so far.
F12	AC auxiliary contactor errors	Hardly appear the code. Never ever happened so far.
F13	Working mode changed/Grid mode changed	1. Lost of one phase or AC voltage detection circuit or relays not closed (old inverter not have relays detection function). 2. Restart the inverter, if the error still exists, please contact your installer or Deye service.
F14	DC firmware over current	Hardly appear the code. Never ever happened so far.
F15	AC firmware over current	1. The internal AC sensor or detection circuit on control board or connection wire may loose. 2. Restart the inverter, if the error still exists, please contact your installer or Deye service.
F16	GFCI(RCD) Ac leakage current fault	1. This fault means the average leakage current is over 300mA. Check whether DC power supply or solar panels is ok, then check 'Test data'-> 'dil' value is about 40; Then check the leakage current sensor or circuit (the following picture). Checking test data needs using big LCD. 2. Restart the inverter, if the error still exists, please contact your installer or Deye service.
F17	Three phase current, over-current fault	Hardly appear the code. Never ever happened so far.
F18	AC over current fault of hardware	1. Check AC sensor or detection circuit on control board or connection wire. 2. Restart the inverter or factory reset, if the error still exists, please contact your installer or Deye service.
F19	All hardware failure synthesis	Hardly appear the code. Never ever happened so far.
F20	DC over current fault of the hardware	1. Check whether solar panel output current is within the allowed range. 2. Check DC current sensor and its detection circuit. 3. Check if the inverter FW version is suitable for the hardware. 4. Restart the inverter, if the error still exists, please contact your installer or Deye service.

Error code	Description	Ongrid - Three Phase
F21	DC leakage flow fault	Hardly appear the code. Never ever happened so far.
F22	Crash stop (if there is a stop button)	Contact your installer for help.
F23	AC leakage current is transient over current	<ol style="list-style-type: none"> 1. This fault means the leakage current is above 30mA suddenly. Check whether DC power supply or solar panels is ok, then check 'Test data'-> 'dil' value is about 40; Then check the leakage current sensor or circuit. Check test data needs using big LCD. 2. Restart the inverter, if the fault still exists, contact your installer or Deye service.
F24	DC insulation impedance failure	<ol style="list-style-type: none"> 1. Check Vpe resistance on main board or detection on control board. Check PV panels is OK. Many times this issue is the PV problem. 2. Check whether the PV panel (aluminum frame) is grounded well and inverter is grounded well. Open the cover of inverter and then check the inside ground cable is fixed well on the shell. 3. Check if the AC/DC cable, terminal block are shorted to ground or the insulation is damaged. 4. Restart the inverter, if the fault still exists, contact your installer or Deye service.
F25	DC feedback fault	Hardly appear the code. Never ever happened so far.
F26	The DC busbar is unbalanced	<ol style="list-style-type: none"> 1. Check whether the 'BUSN' cable or driver board power supply cable is loose. 2. Restart the inverter, if the fault still exists, contact your installer or Deye service.
F27	DC end insulation error	Hardly appear the code. Never ever happened so far.
F28	Inverter 1 DC high fault	Hardly appear the code. Never ever happened so far.
F29	AC load switch failure	Hardly appear the code. Never ever happened so far.
F30	AC main contactor failure	<ol style="list-style-type: none"> 1. Check relays and AC voltage of relays. 2. Check relays driver circuit. Check if the software is not suitable for this inverter. (Old inverter not have relays detection function) 3. Restart the inverter, if the fault still exists, contact your installer or Deye service.
F31	Dc boost soft start	<ol style="list-style-type: none"> 1. At least one Relay can't be closed. Check relays and its driver signal. (Old inverter not have relays detection function) 2. Restart the inverter, if the fault still exists, contact your installer or Deye service.
F32	Inverter 2 dc high fault	Hardly appear the code. Never ever happened so far.
F33	AC over current	Hardly appear the code. Never ever happened so far.
F34	AC current over load	Hardly appear the code. Never ever happened so far.
F35	No AC grid	<ol style="list-style-type: none"> 1. Check AC grid voltage. Check AC voltage detection circuit. Check if the AC connector in good condition. Check whether the AC grid is normal in voltage. 2. Restart the inverter, if the fault still exists, contact your installer or Deye service.
F36	AC grid phase error	Hardly appear the code. Never ever happened so far.
F37	AC three-phase voltage unbalance failure	Hardly appear the code. Never ever happened so far.
F38	AC three-phase current unbalance failure	Hardly appear the code. Never ever happened so far.

Error code	Description	Ongrid - Three Phase
F39	AC over current(one cycle)	1. Check AC current sensor and its circuit. 2. Restart the inverter, if the fault still exists, contact your installer or Deye service.
F40	DC over current	Hardly appear the code. Never ever happened so far.
F41	AC Line W,U over voltage	Check the AC voltage protection setting. And Check if the AC cable is too thin.Check the voltage difference between LCD and meter.
F42	AC Line W,U low voltage	Check the AC voltage protection setting. Check the voltage difference between LCD and meter. Also need to check whether AC cables are all firmly and correctly connected.
F43	AC Line V,W over voltage	Check the AC voltage protection setting.And Check if the AC cable is too thin.Check the voltage difference between LCD and meter.
F44	AC Line V,W low voltage	Check the AC voltage protection setting. Check the voltage difference between LCD and meter. Also need to check whether AC cables are all firmly and correctly connected.
F45	AC Line U,V over voltage	Check the AC voltage protection setting.And Check if the AC cable is too thin.Check the voltage difference between LCD and meter.
F46	AC Line U,V low voltage	Check the AC voltage protection setting.
F47	AC Over frequency	Check the frequency protection setting.
F48	AC lower frequency	Check the frequency protection setting.
F49	U phase grid current DC component over current	Hardly appear the code. Never ever happened so far.
F50	V phase grid current DC component over current	Hardly appear the code. Never ever happened so far.
F51	W phase grid current DC component over current	Hardly appear the code. Never ever happened so far.
F52	AC inductor A, phase current DC current high	Hardly appear the code. Never ever happened so far.
F53	AC inductor B, phase current DC current high	Hardly appear the code. Never ever happened so far.
F54	AC inductor C, phase current DC current high	Hardly appear the code. Never ever happened so far.
F55	DC busbar voltage is too high	1. Check PV voltage and Ubus voltage and its detection circuit. If the PV input voltage exceeds the limit, please reduce the number of solar panels in series. 2. For Ubus voltage, please check the LCD display.
F56	DC busbar voltage is too low	1. It tells the PV input voltage is low and it always happens in the early morning. 2. Check PV voltage and Ubus voltage. When inverter is running, then showing F56, maybe Loss of driver or need update firmware. 3. Restart the inverter, if the fault still exists, contact your installer or Deye service.
F57	AC reverse irrigation	AC reverse irrigation.
F58	AC grid U over current	Hardly appear the code. Never ever happened so far.

Error code	Description	Ongrid - Three Phase
F59	AC grid V over current	Hardly appear the code. Never ever happened so far.
F60	AC grid W over current	Hardly appear the code. Never ever happened so far.
F61	Reactor A phase over current	Hardly appear the code. Never ever happened so far.
F62	Reactor B phase over current	Hardly appear the code. Never ever happened so far.
F63	Reactor C phase over current	Hardly appear the code. Never ever happened so far.
F64	IGBT heat sink high temperature	<ol style="list-style-type: none"> 1. Check temperature sensor. Check if firmware is suitable for the hardware. Check if the inverter is its right model. 2. Restart the inverter, if the fault still exists, contact your installer or Deye service.

Table10.1 Error codes and their solutions



Note:

If your string inverter has any of the fault information shown in Table 10-1, and when you reset the machine and still don't solve the problem, please contact our distributor and provide the below details:

1. Serial number of the inverter;
2. The distributor/dealer of the inverter(if available);
3. Installation date;
4. The discription of problem (include LCD'error code and LED starus indicator lights);
5. Your contact details.

11.Specification

Model	SUN-70K-G03	SUN-75K-G03	SUN-80K-G03
Input Side			
Max.DC Power(kW)	105	112.5	120
Max.DC Input Voltage(V)	1000		
Start-up DC Input Voltage(V)	250		
MPPT Operating Range(V)	200~850		
Max.DC Input Current(A)	40+40+40+40	40+40+40+40	40+40+40+40
Number of MPPT/Strings per MPPT	4/4	4/4	4/4
Output Side			
Rated Output Power(kW)	70	75	80
Max.Active Power(kW)	77	82.5	88
Rated AC Grid Voltage(V)	220/380, 230/400		
AC Grid Voltage Range(V)	277 ~ 460 (this may vary with grid standards)		
Rated Grid Frequency(Hz)	50/60(Optional)		
Operating Phase	Three phase		
Rated AC Grid Output Current(A)	101.5	108.7	115.9
Max.AC Output Current(A)	111.6	119.6	127.5
Output Power Factor	>0.99		
Grid Current THD	<2%		
DC Injection Current(mA)	<0.5%		
Grid Frequency Range	47-52 or 57-62 (optional)		
Efficiency			
Max.Efficiency	98.7%		
Euro Efficiency	98.3%		
MPPT Efficiency	>99%		
General Data			
Size(mm, W×H×D)	838×568×323		
Weight(kg)	73.7		
Topology	Transformerless		
Internal consumption	<1W(Night)		
Operating temperature	-25 ~ 65°C		
Ingress protection	IP65		
Noise Emission(Typical)	<55dB		
Cooling Concept	Smart cooling		
Max. operation altitude	2000m		
Designed Lifetime	>20 Years		
Grid Connection Standard	EN50549, IEC61727, VDE 0126-1-1, IEC62109-1-2		
Operation surrounding humidity	0~100%		
Safety EMC / Standard	IEC62109-1/-2,AS3100,EN61000-6-1		
General Data			
DC Connection	MC-4 mateable		
AC Connection	IP65 rated plug		
Display	LCD 240 × 160		
Interface	RS485/RS232/Wifi/LAN		

Model	SUN-90K-G03	SUN-100K-G03	SUN-110K-G03
Input Side			
Max.DC Power(kW)	135	150	150
Max.DC Input Voltage(V)	1000	1000	1100
Start-up DC Input Voltage(V)	250		
MPPT Operating Range(V)	200~850		
Max.DC Input Current(A)	40+40+40+40	40+40+40+40+40+40	40+40+40+40+40+40
Number of MPPT/Strings per MPPT	4/4	6/4	6/4
Output Side			
Rated Output Power(kW)	90	100	110
Max.Active Power(kW)	99	110	121
Rated AC Grid Voltage(V)	220/380, 230/400		
AC Grid Voltage Range(V)	277 ~ 460 (this may vary with grid standards)		
Rated Grid Frequency(Hz)	50/60(Optional)		
Operating Phase	Three phase		
Rated AC Grid Output Current(A)	130.4	144.9	159.4
Max.AC Output Current(A)	143.5	159.4	175.4
Output Power Factor	>0.99		
Grid Current THD	<2%		
DC Injection Current(mA)	<0.5%		
Grid Frequency Range	47-52 or 57-62 (optional)		
Efficiency			
Max.Efficiency	98.7%		
Euro Efficiency	98.3%		
MPPT Efficiency	>99%		
General Data			
Size(mm, W×H×D)	838×568×323		
Weight(kg)	73.7		
Topology	Transformerless		
Internal consumption	<1W(Night)		
Operating temperature	-25 ~ 65°C		
Ingress protection	IP65		
Noise Emission(Typical)	<55dB		
Cooling Concept	Smart cooling		
Max. operation altitude	2000m		
Designed Lifetime	>20 Years		
Grid Connection Standard	EN50549, IEC61727, VDE 0126-1-1, IEC62109-1-2		
Operation surrounding humidity	0~100%		
Safety EMC / Standard	IEC62109-1/-2, AS3100, EN61000-6-1		
General Data			
DC Connection	MC-4 mateable		
AC Connection	IP65 rated plug		
Display	LCD 240 × 160		
Interface	RS485/RS232/Wifi/LAN		

NINGBO DEYE INVERTER TECHNOLOGY CO., LTD.

Add: No.26-30, South Yongjiang Road, Beilun, 315806, Ningbo, China

Tel: +86 (0) 574 8622 8957

Fax: +86 (0) 574 8622 8852

E-mail: service@deye.com.cn

Web: www.deyeinverter.com

502012008 Ver: 1.0, 2020-11