

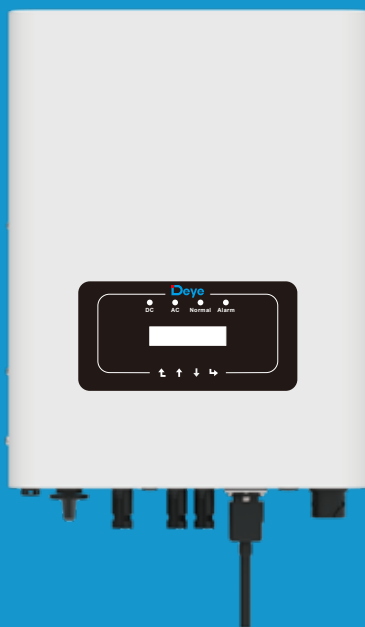

Grid-connected PV Inverter

SUN-8K-G03-LV

User Manual



Contents

1. Introduction	- 01 -
1.1 Appearance Introduction	- 01 -
1.2 Parts list	- 02 -
2. Safety warnings and instructions	- 03 -
2.1 Safety signs	- 03 -
2.2 Safety instructions	- 03 -
2.3 Notes for using	- 04 -
3. Operation Interface	- 05 -
3.1 Interface View	- 05 -
3.2 Status Indicator	- 05 -
3.3 Buttons	- 06 -
3.4 LCD Display	- 06 -
4. Product installation	- 07 -
4.1 Select installation location	- 07 -
4.2 Inverter Installation	- 09 -
5. Electrical Connection	- 11 -
5.1 DC input terminal connection	- 11 -
5.2 AC input terminal connection	- 13 -
5.3 The connection of the ground line	- 16 -
5.4 Max. over current protection device	- 17 -
5.5 Inverter monitoring connection	- 17 -
5.6 Installation of datalogger	- 18 -
5.7 Configuration of Datalogger	- 18 -
6. Startup and Shutdown	- 18 -
6.1 Start up the inverter	- 19 -
6.2 Inverter Shutdown	- 19 -
6.3 Anti-PID Function(option)	- 19 -
7. Zero export function via energy meter	- 20 -
7.1 Multiple strings and parallel connection meters	- 24 -
7.2 Use of zero-export function	- 29 -
7.3 Notes while using zero export function	- 30 -
7.4 How to browse the load power of your PV grid-tieplant on monitoring platform	- 30 -
8. General Operation	- 32 -
8.1 The initial interface	- 35 -
8.2 Submenus in the Main Menu	- 36 -
8.3 System param setting	- 38 -
8.4 Running param set	- 38 -
8.5 Protect Param	- 54 -
8.6 Comm. param set	- 56 -
9. Repair and Maintenance	- 57 -
10. Error information and processing	- 57 -
10.1 Error code	- 58 -
11. Specification	- 62 -

About This Manual

The manual mainly describes the product information, guidelines for installation, operation and maintenance. The manual cannot include complete information about the photovoltaic (PV) system.

How to Use This Manual

Read the manual and other related documents before performing any operation on the inverter. Documents must be stored carefully and be available at all times. **Contents may be periodically updated or revised due to product development. The information in this manual is subject to change without notice.** The latest manual can be acquired via service@deye.com.cn.

Photovoltaic Grid-connected System

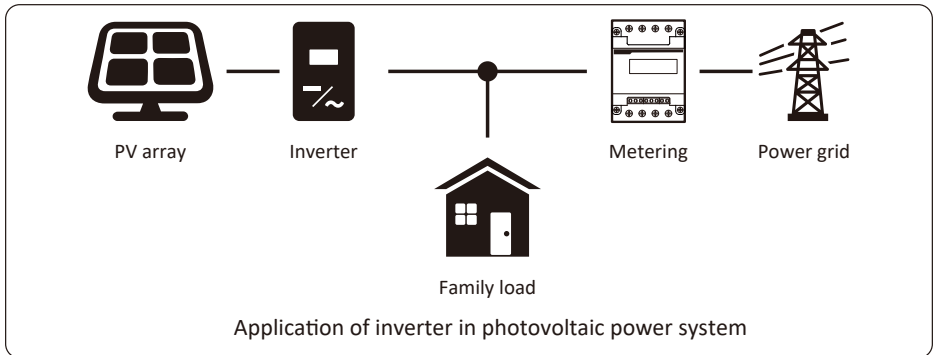

1. Introduction

1.1 Appearance Introduction

On-grid inverter can convert solar panel DC power into AC power which can directly input to the grid. Its appearance is shown below. These models contain SUN-8K-G03-LV. The following is collectively referred to as “inverter”.

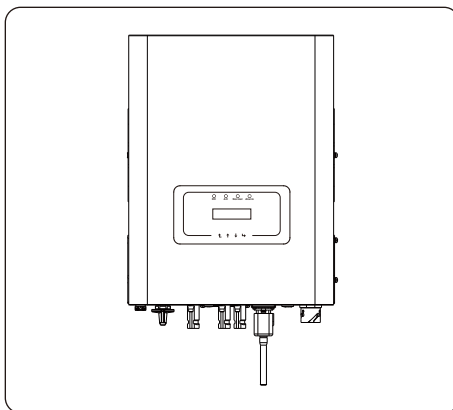

Pic 1.1 Front view

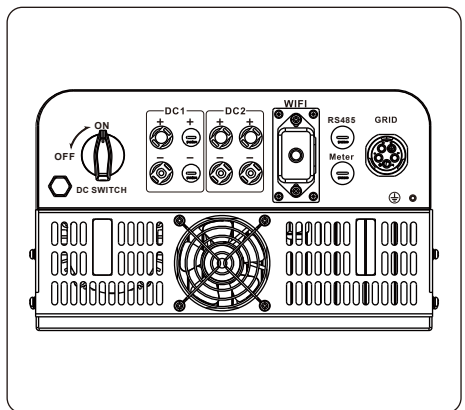

Pic 1.2 Bottom view

1.2 Parts list

Please check the following table, to see whether all the parts are included in the package :

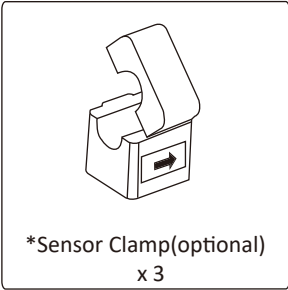
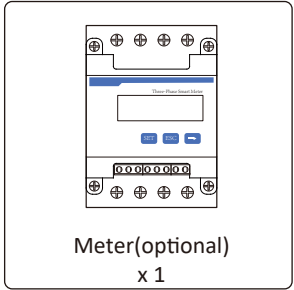
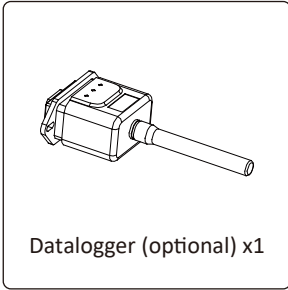
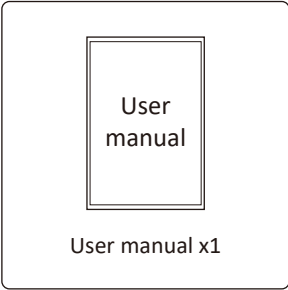
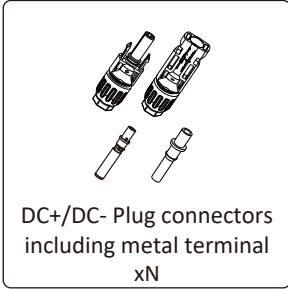
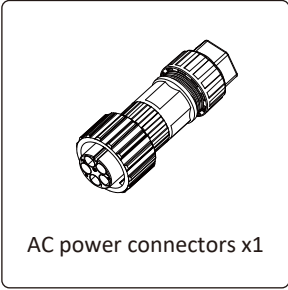
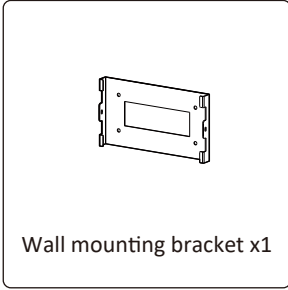
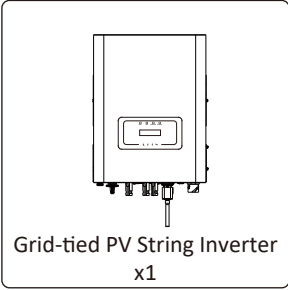

2. Safety warnings and instructions

Improper use may result in potential electric shock hazards or burns. This manual contains important instructions that should be followed during installation and maintenance. Please read these instructions carefully before use and keep them for future reference.

2.1 Safety signs

Safety symbols used in this manual, which highlight potential safety risks and important safety information, are listed as follows:



Warning:

Warning symbol indicates important safety instructions, which if not correctly followed, could result in serious injury or death.



Shock Hazard:

Caution, risk of electric shock symbol indicates important safety instructions, which if not correctly followed, could result in electric shock.



Safety Hint:

Note symbol indicates important safety instructions, which if not correctly followed, could result in some damage or the destruction of the inverter.



High Temperature Hazard:

Caution, hot surface symbol indicates safety instructions, which if not correctly followed, could result in burns.

2.2 Safety instructions



Warning:

Electrical installation of the inverter must conform to the safety operation rules of the country or local area.



Warning:

Inverter adopts non-isolated topology structure, hence must insure DC input and AC output are electrical isolated before operating the inverter.



Shock Hazard:

Prohibit disassembling inverter case, there existing shock hazard, which may cause serious injury or death, please ask qualified person to repair.



Shock Hazard:

When PV module is exposed to sunlight, the output will generate DC voltage. Prohibit touching to avoid shock hazard.



Shock Hazard:

While disconnect the input and output of the inverter for maintenance, please waits for at least 5 mins until the inverter discharge the remnant electricity.



High Temperature Hazard:

Local temperature of inverter may exceed 80 °C while under operating. Please do not touch the inverter case.

2.3 Notes for using

The three phase string power inverter is designed and tested under related safety regulations. It can ensure the personal safety of the user. But as a electric device, it may cause shock or injury by incorrect operation. Please operate the unit under below requirements:

1. Inverter should be installed and maintained by qualified person under local standard regulations.
2. Must disconnect the AC side first, then disconnect DC side while doing installation and maintenance, after that, please wait at least 5 mins to avoid getting shocked.
3. Local temperature of the inverter may exceed 80 °C while under operating. Do not touch to avoid getting injured.
4. All electrical installation must be in accord with local electrical standards, and after obtaining the permission of the local power supply department, the professionals can connect the inverter to the grid.
5. Please take appropriate anti-static measure.
6. Please install where children can not touch.
7. The steps to start the inverter: 1) switch on the AC side circuit breaker, 2) Switch on the DC side circuit breaker of the PV panel. 3) Turn on the DC switch of the inverter.

The steps to stop the inverter: 1) switch off the AC side circuit breaker, 2) switch off the DC side circuit breaker of the PV panel. 3) Turn off the DC switch of the inverter.

8. Don't insert or remove AC and DC terminals when the inverter is in normal operation.
9. The DC input voltage of the inverter must not exceed the maximum value of the model.

3. Operation Interface

3.1 Interface View



Pic 3.1 Front panel display

3.2 Status Indicator

There are four LED status indicator lights in the front panel of the inverter. Please see table 3.1 for details.

Indicator	status	Explanation
● DC	on	Inverter detects DC input
	off	Low DC input voltage
● AC	on	Grid Connected
	off	Grid Unavailable
● NORMAL	on	Under normal operating
	off	Stop operating
● ALARM	on	Detected faults or report faults
	off	Under normal operating

Table 3.1 Status indicator lights

3.3 Buttons

There are four keys in the front panel of the Inverter(from left to right): Esc, Up, Down and Enter keys. The keypad is used for:

- Scrolling through the displayed options (the Up and Down keys);
- Access to modify the adjustable settings (the Esc and Enter keys).

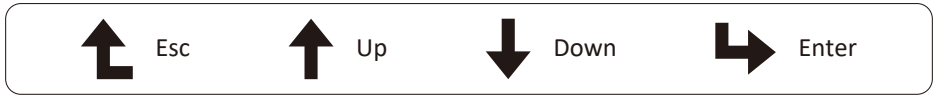

3.4 LCD Display

The two-line Liquid Crystal Display (LCD) is located on the front panel of the Inverter, which shows the following information:

- Inverter operation status and data;
- Service messages for operator;
- Alarm messages and fault indications.

4. Product installation

4.1 Select installation location

To select a location for the inverter, the following criteria should be considered:

WARNING: Risk of fire

- Do not install the inverter in areas containing highly flammable materials or gases.
- Do not install the inverter in potentially explosive atmospheres.
- Do not install in small closed spaces where air can not circulate freely. To avoid overheating, always make sure the flow of air around the inverter is not blocked.
- Exposure to direct sunlight will increase the operational temperature of the inverter and may cause output power limiting. It is recommended that inverter installed to avoid direct sunlight or raining.
- To avoid overheating ambient air temperature must be considered when choosing the inverter installation location. It is recommended that using a sun shade minimizing direct sunlight when the ambient air temperature around the unit exceeds 100°F/40 C.



- Install on a wall or strong structure capable of bearing the weight.
- Install vertically with a maximum incline of $\pm 15^\circ$. If the mounted inverter is tilted to an angle greater than the maximum noted, heat dissipation can be inhibited, and may result in less than expected output power.
- If install more than one inverter, must leave at least 500mm gap between each inverter. And each inverter must be at least 500mm above and below. And must install the inverter at the place where children cannot touch. Please see picture 4.3.
- Consider whether the installation environment is helpful to see the inverter LCD display and indicator status clearly.
- Must offer a ventilate environment if inverter installed in the airtight house.



Safety Hint:

Do not place or store any items next to the inverter.

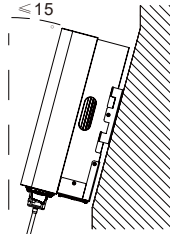
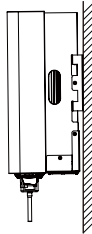
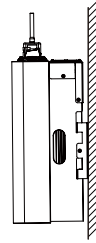
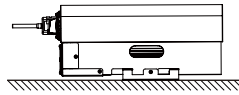
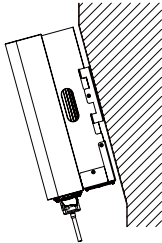

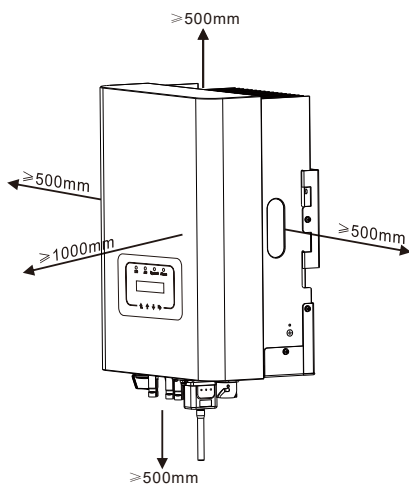

Pic 4.3 Installation Gap

4.2 Inverter Installation

The inverter is designed according to the wall mounted type installation, please use the wall mounted (the brick wall of the expansion bolt) when installing.

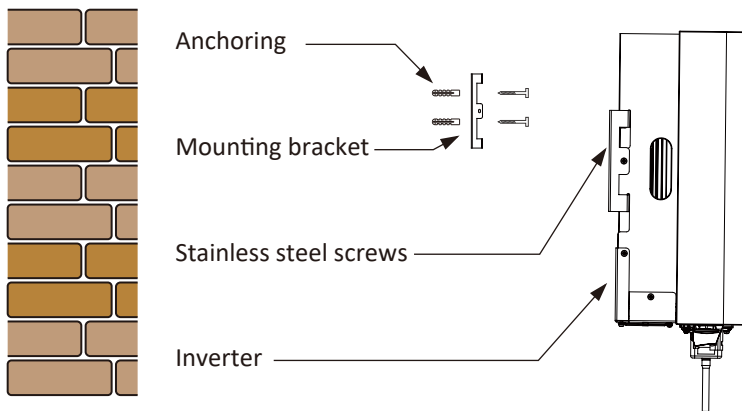

Pic 4.4 Inverter Installation

Procedure shows below:

1. Locate on the appropriate wall according to the bolt position on the mounting bracket, then mark the hole. On the brick wall, the installation must be suitable for the expansion bolt installation.

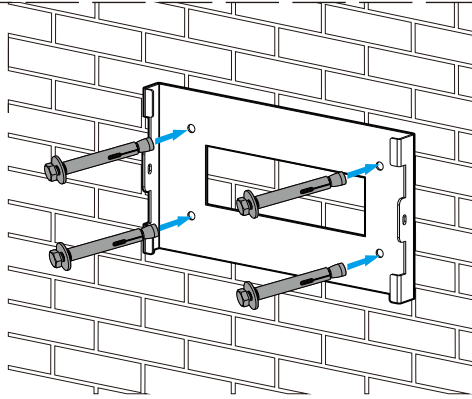

Pic 4.5 Inverter hanging plate installation

2. Ensure that the position of the installation holes on the wall is in accordance with the mounting plate, and the mounting rack is vertically placed.
3. Hang the inverter to the top of the mounting rack and then use the M4 screw in the accessory to lock inverter heat sink to the hanging plate, to ensure that the inverter will not move.

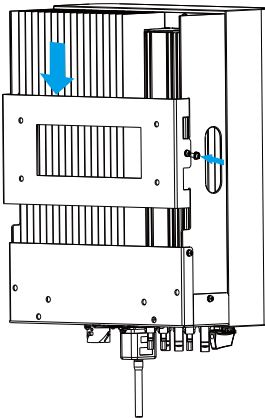

Pic 4.6 Inverter installation

5 Electrical Connection

5.1 DC input terminal connection

1. Switch the Grid Supply Main Switch(AC)OFF.
2. Switch the DC Isolator OFF.
3. Assemble PV input connector to the inverter.



Warning:

When using PV modules, please ensure the PV+ & PV- of solar panel is not connected to the system ground bar



Safety Hint:

Before connection, please make sure the polarity of the output voltage of PV array matches the “DC+” and “DC-” symbols.



Warning:

Before connecting inverter, please make sure the PV array open circuit voltage is within the 800V of the inverter.

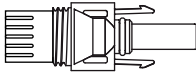

Pic 5.1 DC+ male connector



Pic 5.2 DC- female connector



Safety Hint:

Please use approved DC cable for PV system.

Cable type	Cross section (mm ²)	
	Range	Recommended value
Industry generic PV cable (model: PV1-F)	4.0~6.0 (12~10AWG)	4.0(12AWG)

Table 5.1 DC Cable Specifications

The steps to assemble the DC connectors are listed as follows:

a) Strip off the DC wire about 7mm, disassemble the connector cap nut (see picture 5.3).

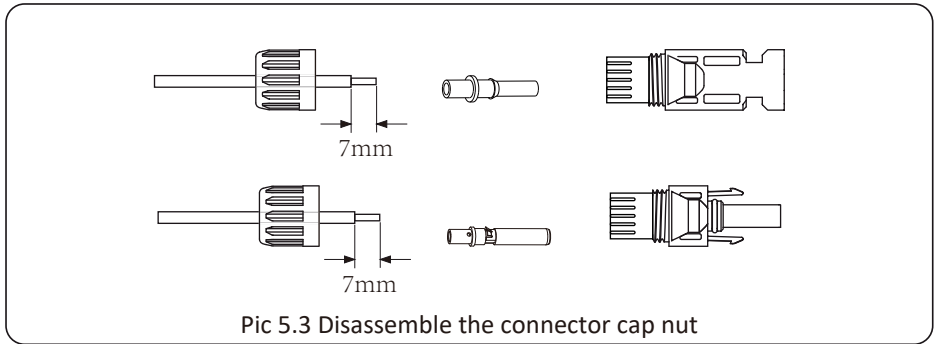

b) Crimping metal terminals with crimping pliers as shown in picture 5.4.

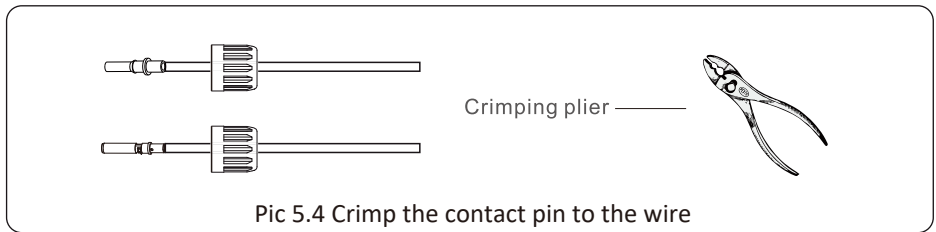

c) Insert the contact pin to the top part of the connector and screw up the cap nut to the top part of the connector. (as shown in picture 5.5).

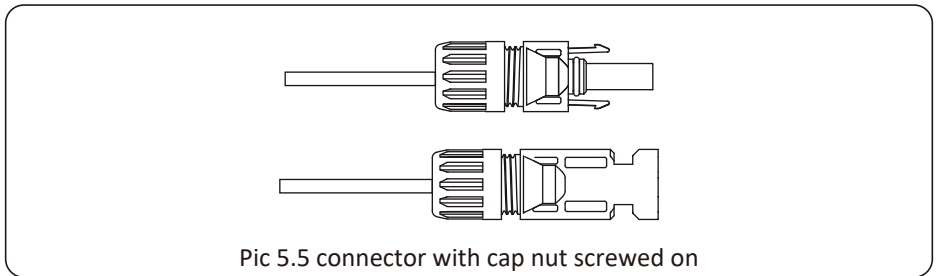

d) Finally insert the DC connector into the positive and negative input of the inverter, shown as picture 5.6

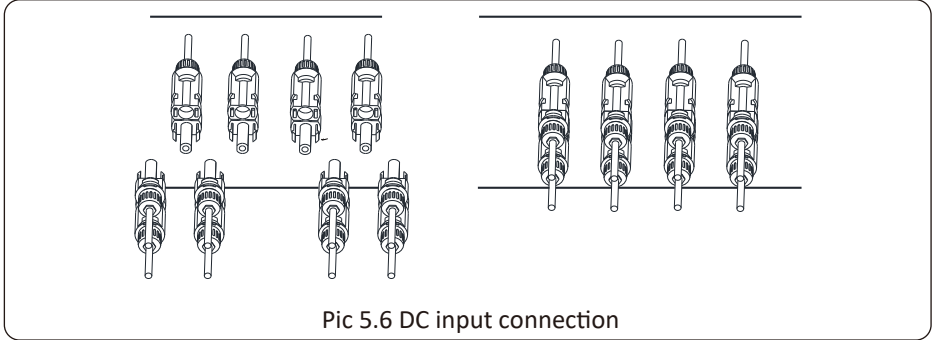

Warning:



Sunlight shines on the panel will generate voltage, high voltage in series may cause danger to life. Therefore, before connecting the DC input line, the solar panel needs to be blocked by the opaque material and the DC switch should be 'OFF', otherwise, the high voltage of the inverter may lead to life-threatening conditions.

Warning:



Please use its own DC power connector from the inverter accessories. Do not interconnect the connectors of different manufacturers. Max. DC input current should be 20A. if exceeds, it may damage the inverter and it is not covered by Deye warranty.

5.2 AC input terminal connection

Do not close the DC switch after the DC terminal is connected. Connect the AC terminal to the AC side of the inverter, the AC side is equipped with Three phase AC terminals that can be conveniently connected. Flexible cords are recommended for easy installation. The are as shown in Table 5.2.

Warning:



Prohibit using a single circuit breaker for multiple inverters, prohibit the connection of load between inverter circuit breakers.

Model	Cable CSA	Cable outer dia	AWG	Breaker	Max cable length
SUN-8K-G03-LV	6mm ²	20-25mm	10	30A/400V	Outside cable (3+N+PE)20m

Table 5.2 Cable information

The AC output connector is divided into three parts: matching socket, sleeve and sealing-sleeve, as shown in picture 5.7, the steps are as follows:

- Step 1: Remove the cable sealing ring and sleeve in sequence from the AC connector.
- Step 2: Use strippers to strip the protective sheath and insulation layer of the AC cable to the right length, as shown in Picture 5.8.

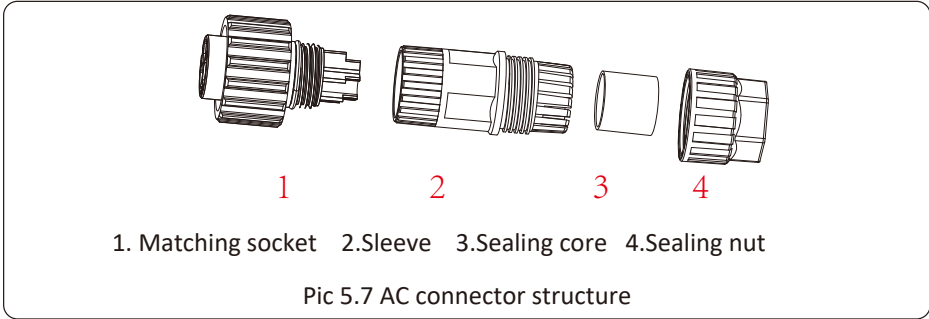

Step 3: Insert the cable (L1, L2, L3, N, PE) into the sealing sleeve.

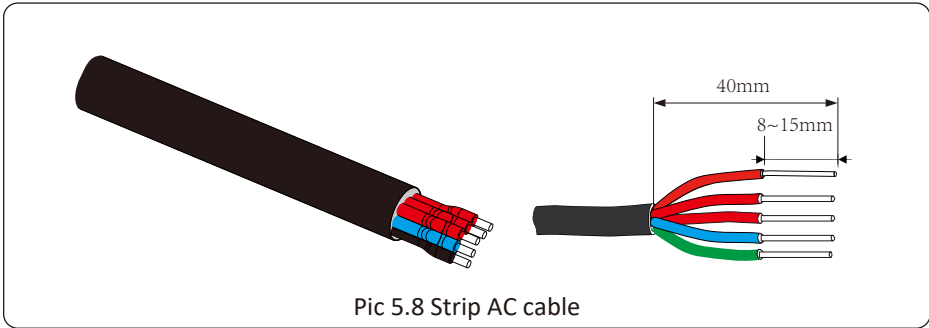

Warning:
Be careful to distinguish the L1, L2, L3, N and PE of the AC cables.

Step 4: Use the hexagon screwdriver, loosen the bolts of the socket in turn, and insert each cable core into the corresponding jack, and set each screw. The connection hole of AC connection terminal labeling is shown in Picture 5.9.

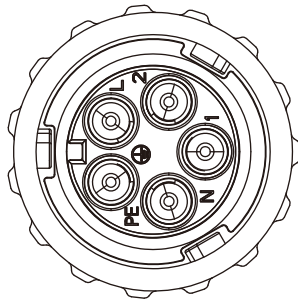

Pic 5.9 AC Connector Hole Pattern

Step 5: Set the sleeve and sealing ring in place.

Step 6: Connect the terminals to the inverter as shown in picture 5.10.

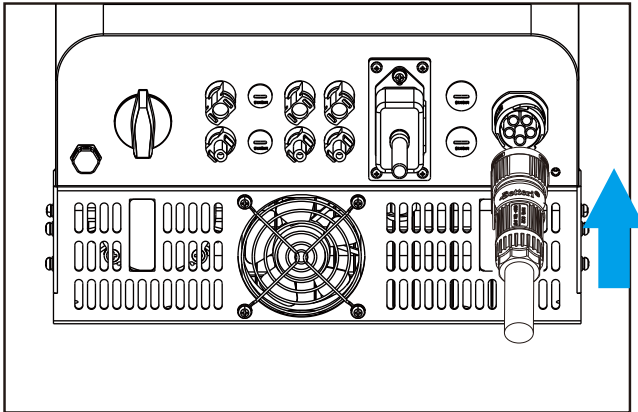

Pic 5.10 AC input connection

5.3 The connection of the ground line

Good grounding is good for resisting surge voltage shock and improving EMI performance. Therefore, before connecting AC, DC and communication cables, you need to ground the cable firstly. For a single system, just ground the PE cable. For multiple machine systems, all PE cables of the inverter need to be connected to the same grounding copper platoon to ensure the equipotential connection. The installation of the shell ground wire is shown as picture 5.11.

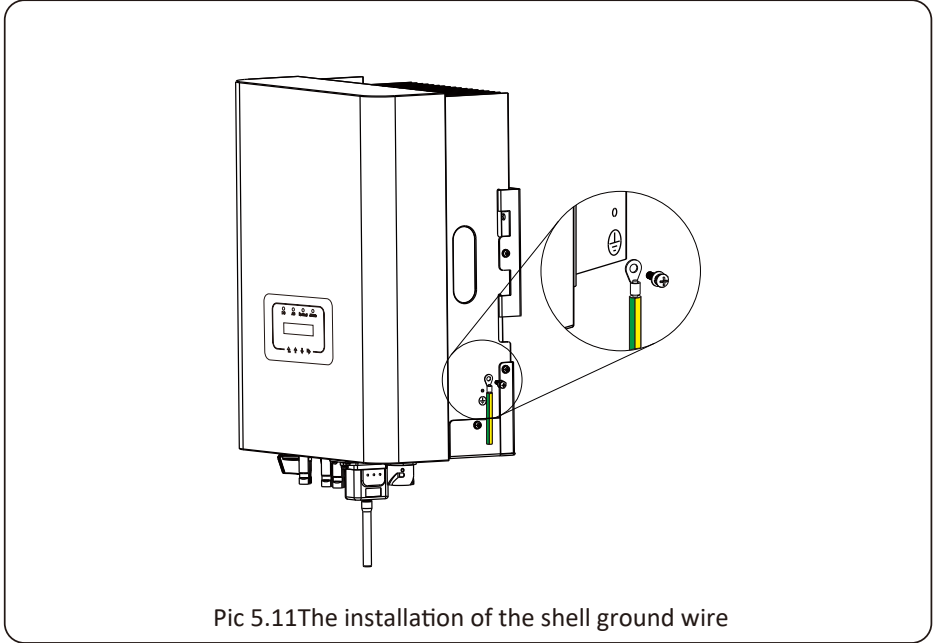

Pic 5.11 The installation of the shell ground wire



Warning:

Inverter has built-in leakage current detection circuit, If an external leakage current protection device is connected, its operating current must be greater than 300 mA or higher, otherwise inverter may not work properly.

5.4 Max. over current protection device

In order to protect the inverter AC connection, it is recommended to install a circuit breaker to prevent overcurrent. See table 5.3 below.

<i>Inverter</i>	<i>Rated output voltage(V)</i>	<i>Rated output current(A)</i>	<i>Current for protection device(A)</i>
SUN-8K-G03-LV	230	21.8	30

Table 5.3 Recommended current protector specifications

5.5 Inverter monitoring connection

Inverter has the function of wireless remote monitoring. The inverter with Wi-Fi function is equipped with Wi-Fi Plug to connect the inverter and network. Wi-Fi Plug's operation, installation, Internet access, APP downloading and other processes are detailed in the instructions.

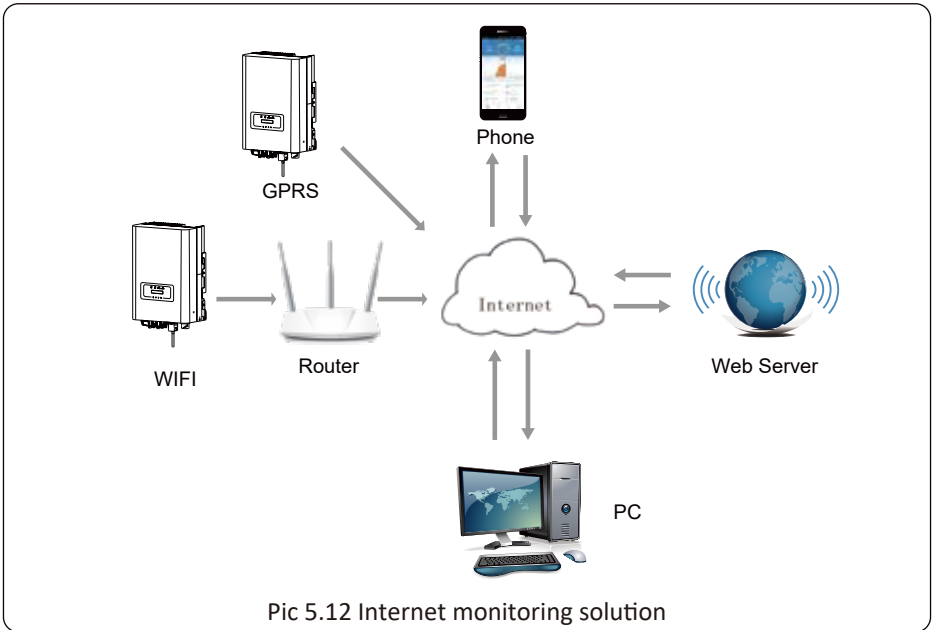

Pic 5.12 Internet monitoring solution

5.6 Installation of datalogger

When installing the WiFi stick, tear off the sealing strip on the inverter. Insert the datalogger into the interface and fix it with a screw. The configuration of the datalogger needs to be performed after various electrical connections have been completed and the inverter DC power on. When the inverter is on the DC power, it is determined whether the datalogger is normally electrified (The LED light shines out of the shell).

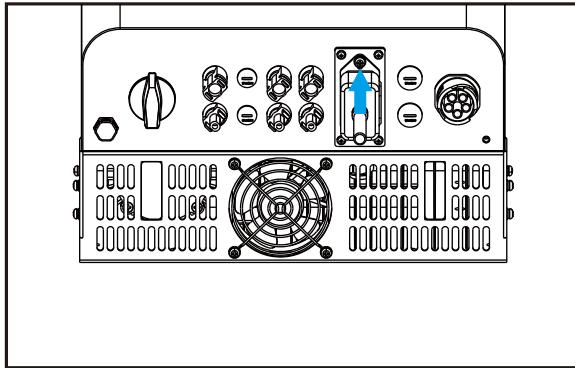

Pic 5.13 Datalogger installation diagram

5.7 Configuration of datalogger

For the configuration of datalogger, please refer to illustrations of the datalogger.

6. Startup and Shutdown

Before starting the inverter, make sure that the inverter can meet the following conditions, otherwise it may result in fire or damage to the inverter. In this case, we do not undertake any responsibility. At the same time, to optimize the system configuration, it is recommended that the two inputs be connected to the same number of photovoltaic modules.

- a). The maximum open circuit voltage of each set of photovoltaic modules shall not exceed 800Vdc under any conditions.
- b). Each input of the inverter better use the same type of photovoltaic module in series.
- c). Total output power of PV shall not exceed the maximum input power of inverter, each photovoltaic modules shall not exceed the rated power of each channel.

6.1 Start up the inverter

When starting up the three phase string inverter, should follow steps below:

1. Starting switch on the AC breaker.
2. Turn on the DC switch of the photovoltaic module, and if the panel provides sufficient starting voltage and power, the inverter will start.
3. The inverter will first check the internal parameters and the grid parameters, while the liquid crystal will show that the inverter is self-checking.
4. If the parameter is within acceptable range, the inverter will generate energy. NORMAL indicator light is on.

6.2 Inverter Shutdown

Must follow below steps while shutting down the inverter:

1. Switch off the AC breaker.
2. Wait for 30 seconds, turn off the DC switch (if any), or simply disconnect the DC input connector. The inverter will close the LCD and all LED within two minutes.

6.3 Anti-PID Function(option)

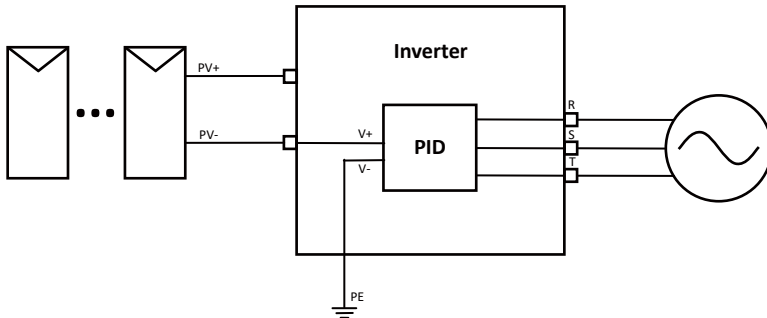

The Anti-PID module repairs the PID effect of the PV module at night. The PID module always runs when connected to AC.

If maintenance is required and turn off the AC switch can disable the Anti-PID function.



Warning:

The PID functionality is automatic. When the DC bus voltage is below 50VDC, the PID module will create 450VDC between the PV and ground. No control and equipment are required.



Warning:

If you need to maintain the inverter, Please turn off the AC switch first, then turn off the DC switch, and wait 5 minutes before you do other operations.

7. Zero-export function via energy meter

There're two kinds of energy meters for this series inverter. First type is Eastron SDM630-Modbus V2 which is able to measure the Max. 100A current directly. More details please refer to Pic 7.1 & 7.2. For the Eastron SDM630 MCT 40mA, it needs external CT to measure the current. The CT power range is from 5A-2000A. More details about the Eastron SDM630 MCT, please refer to Pic 7.3 & 7.4. Also, the CHNT meter DTSU666 is supported, it can measure the Max. 80A current directly. More details about the DTSU666, please refer to Pic 7.5 & 7.6.

When you are reading this, we believe that you have completed the connection according to the requirements of chapter 5, if you have been running your inverter at this time, and you want to use the zero-export function, please turn off AC and DC switch of the inverter, and wait for 5 minutes until the inverter completely discharged. Please follow below Picture 7.1 to connect the energy meter.

For system wiring diagram, the red line refers to L line (L1, L2, L3), the black line refers to the neutral line (N). Connecting energy meter RS485 cable to inverter's RS485 port. It's recommended to install an AC switch between the inverter and the utility grid, the specs of the AC switch are determined by the power of load.

If there is no integrated DC switch inside the inverter you purchased, we commend you to connect the DC switch. The voltage and current of the switch depend on the PV array you access.

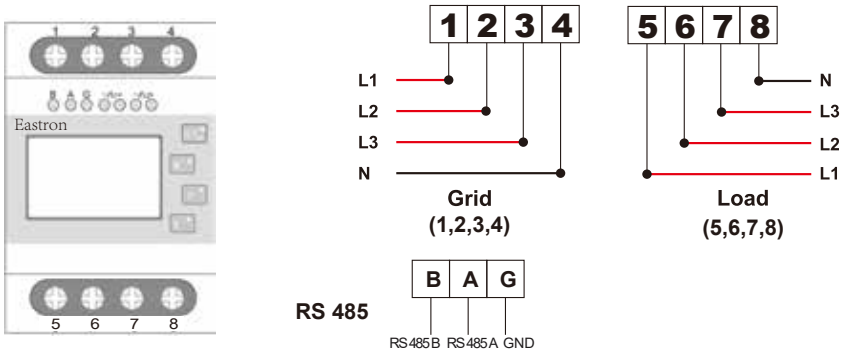

Eastron SDM630-Modbus V2

Pic 7.1 Eastron meter

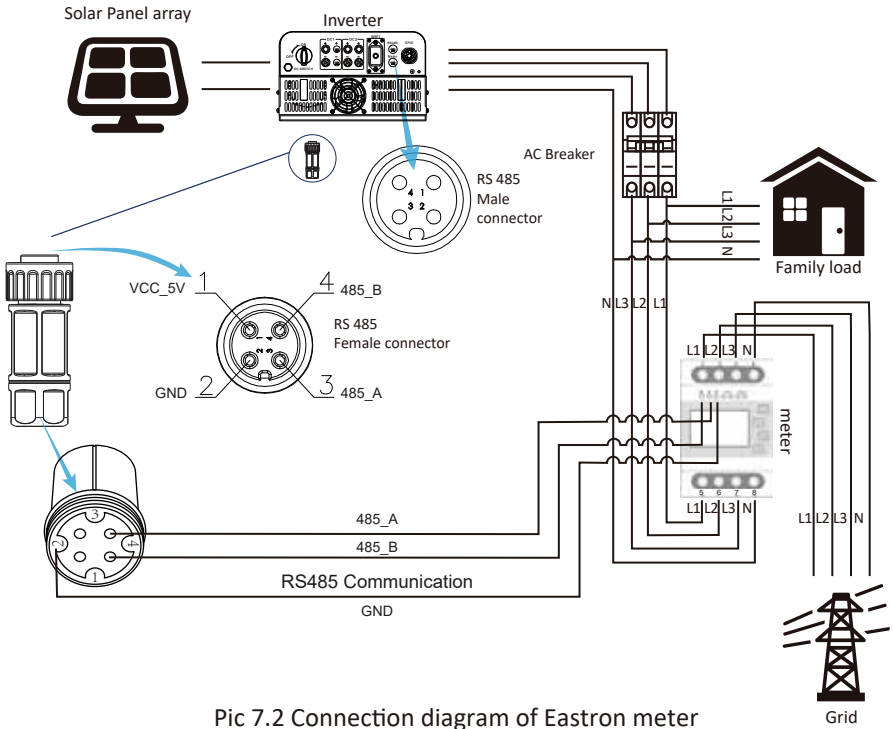

Pic 7.2 Connection diagram of Eastron meter



Warning:

In final installation, breaker certified according to IEC 60947-1 and IEC 60947-2 shall be installed with the equipment.

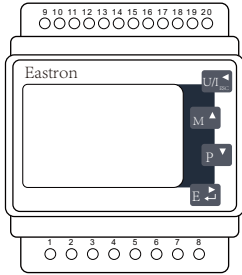

Eastron SDM630MCT

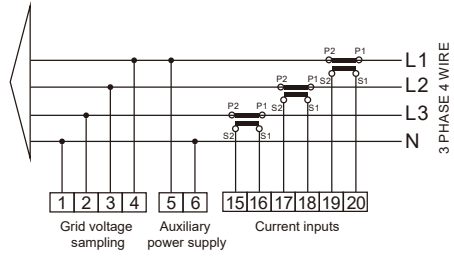

RS 485

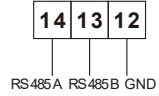

Pic 7.3 Eastron meter

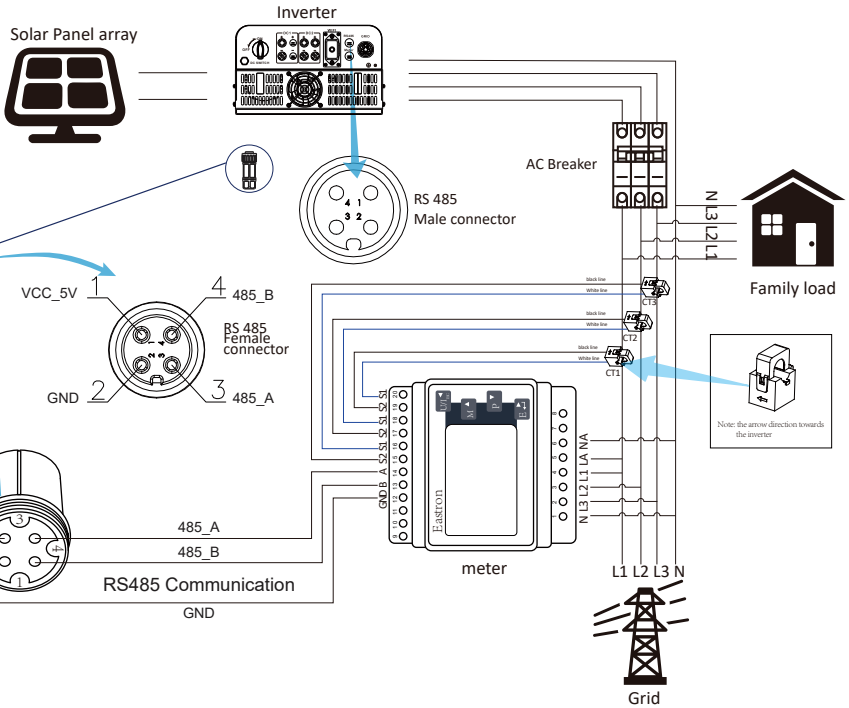

Pic 7.4 Connection diagram of Eastron meter

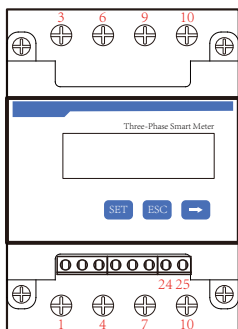

CHNT DTSU666

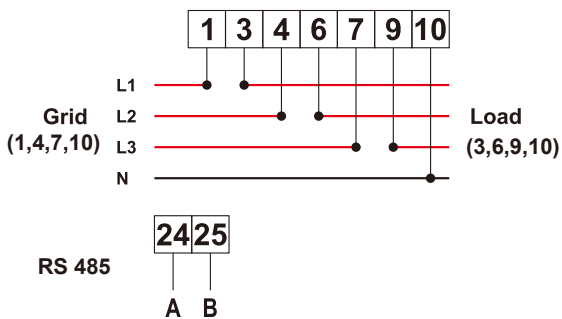

Pic 7.5 CHNT meter

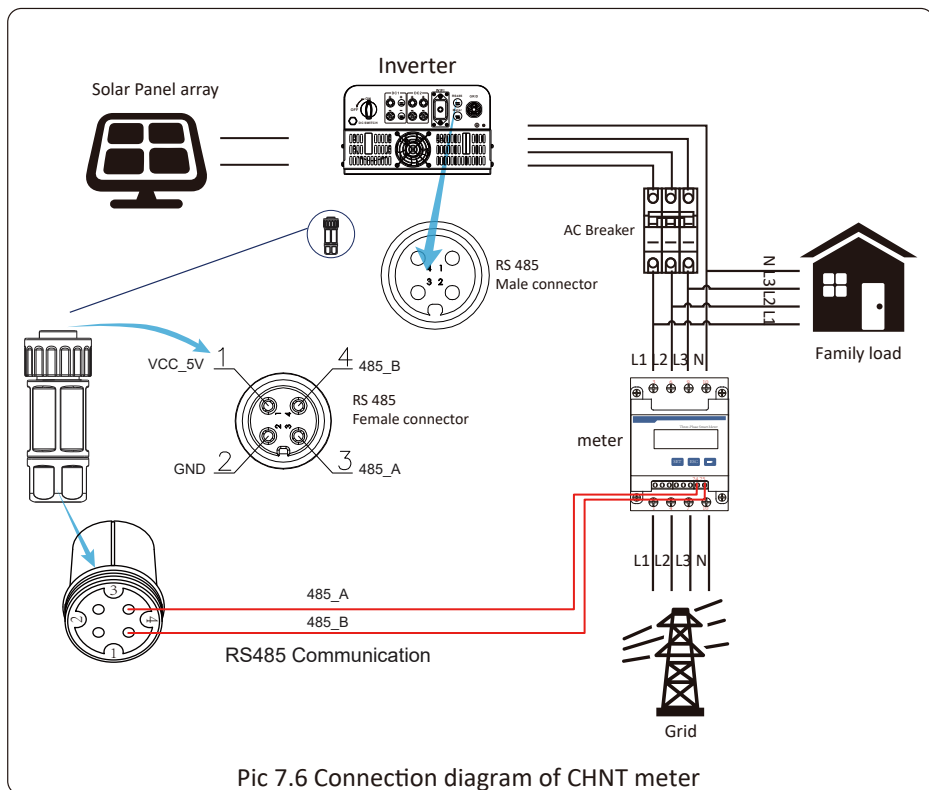

Pic 7.6 Connection diagram of CHNT meter

7.1 Multiple strings and parallel connection meters

This application is that when the string inverters work in parallel, there is only one power grid and one load, and only one meter can be connected to prevent reverse current, so only this many-to-one anti-reverse current connection can be connected.

If there's several inverters in a plant, also it can use 1pcs meter to realize zero export function. For example, if there's 3pcs inverter in the system with 1pcs meter. We need to setup 1pcs inverter as the master and others setup as slaves. And, all of them need to connect to the meter via RS485. Below is the system diagram and configuration of the system.

Meter	OFF <<	Exp_Mode	AUG <<
Limiter	OFF	CT_Ratio	0
MFR	ACREL	Shunt	OFF
FeedIn	0,0KW <<	ShuntQTY	1 <<
Generator	ON	G_MFR	CHNT
G_CT	1 <<	G_FeedIn	0% <<
G_Cap	0,0KW		
Back	<<		

Pic 7.7 Meter function

Name	Description	Range
Exp_Mode	AVG: Average power of three phase is zero exported. MIN: Phase with minimum load power is zero exported, while the other two phase may be in purchase mode.	AVG/MIN
CT_Ratio	CT ratio of power grid side meter when extern CT is applied.	1-1000
MFR	Manufacturer of the grid side meter. Modbus Address of it should be set as 01.	AUTO/CHNT/ EASTRON
Feedin	Percentage of the Feed in power exported to the grid.	0-110%
Shunt	Parallel mode. Set one inverter as Master, others are Slave. ONLY need to set the master, Slave will follow the settings in the master.	OFF/Master/ Slave
ShuntQTY	Number of inverters in parallel	1-16
Generator	DG side meter function Enable/Disable	ON/OFF
G.CT	CT ratio of power DG side meter when extern CT is applied.	1-1000
G.MFR	Manufacturer of the DG side meter. Modbus Address of it should be set as 02.	AUTO/CHNT/ EASTRON
G.FeedIn	Output power percentage of the DG.	0-110%
G.Cap	Capacity of the DG.	1-999kW

Note: Select Meter option in Run Param and long press ENTER button to enter this Meter Setting page.

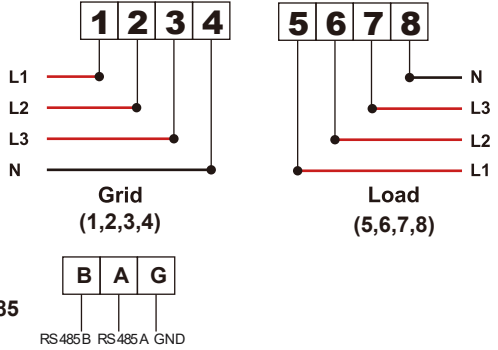

Eastron SDM630-Modbus V2

Pic 7.8 Eastron meter

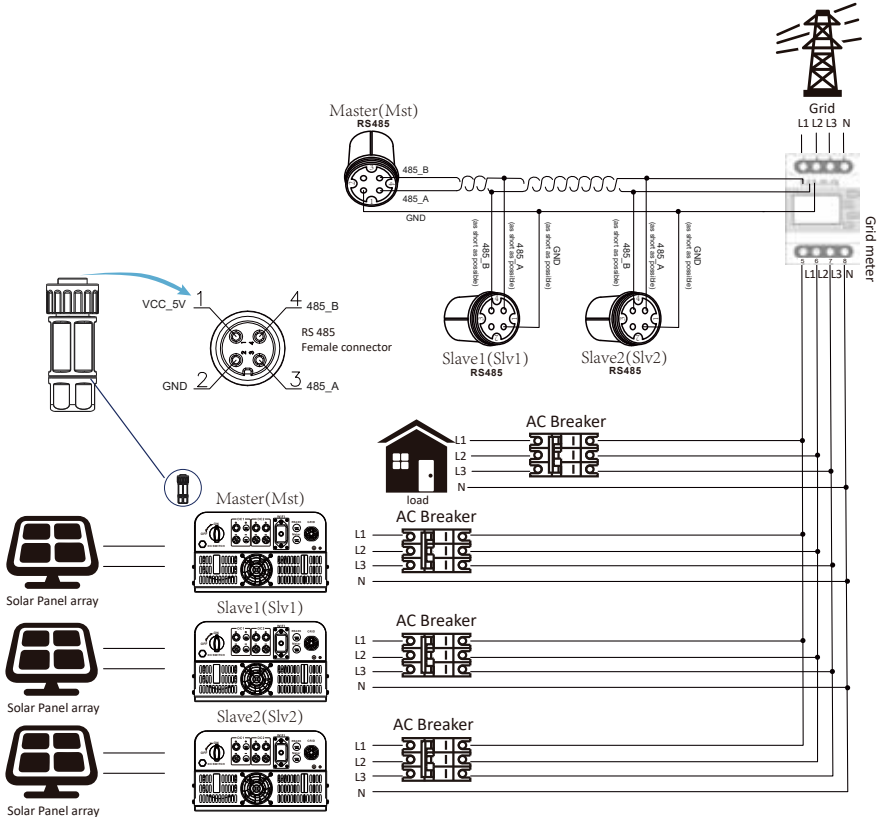

Pic 7.9 Eastron Connection diagram(The pass-through table)

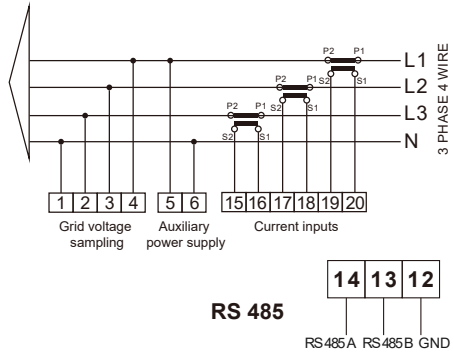
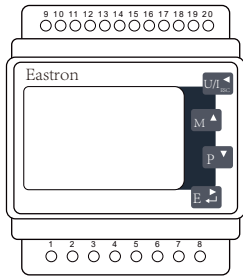

Eastron SDM630MCT

Pic 7.10 Eastron meter

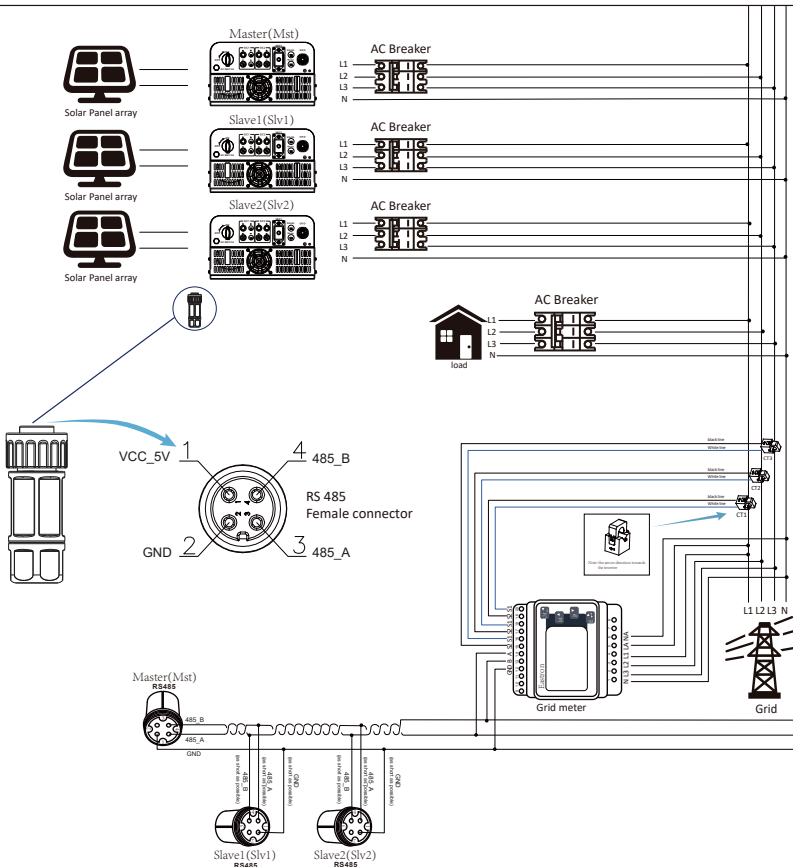

Pic 7.11 Connection diagram(Three-phase electricity)

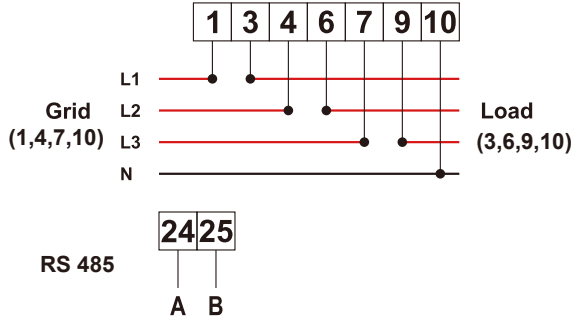
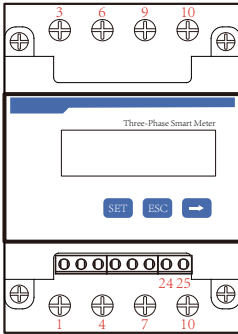

CHNT DTSU666

Pic 7.12 CHNT meter

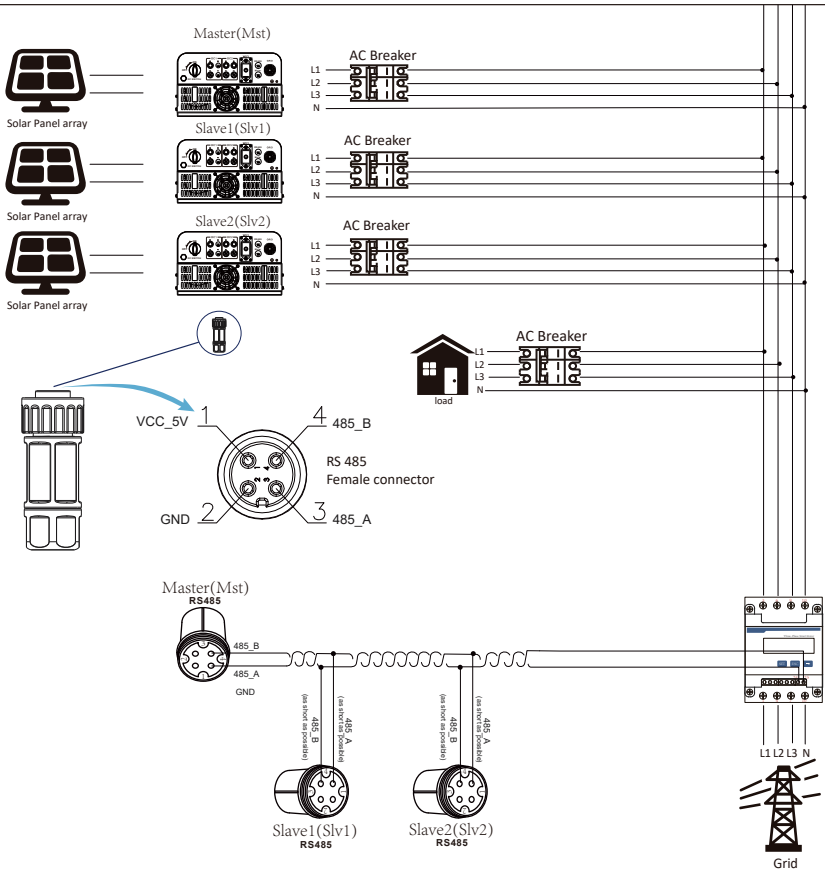

Pic 7.13 CHNT Connection diagram(The pass-through table)

7.2 Use of zero-export function

When the connection is completed, the following steps should be referred to use this function:

1. Turn on the AC switch.
2. Turn on the DC switch, waiting for the inverter's LCD is turned on.
3. Press Enter button on the LCD panel in the main interface into the menu options, select [parameter setting] to enter setup submenu, and then select [running parameters] as shown in picture 7.14, at this time please input the default password 1234 through pressing the button [up down, enter], enter the operation parameter setting interface, shown as picture 7.15.



Pic 7.14 Parameter setting



Pic 7.15 Meter switch

4. Operate the button [up down], move setting cursor to energy meter and press the button [enter]. At this time you can turn on or turn off the energy meter by choosing [up down] button, please press [enter] button to confirm when setting done.
5. Move the cursor to [OK], press [enter] to save the settings and exit the running parameters page, otherwise the settings are invalid.
6. If set up successfully, you can return to the menu interface, and display the LCD to [home page] by press the [up down] button. If it displays [meter power XXW], the zero-export function setting is completed. Shown as picture 7.16.



Pic 7.16 Zero-export function via energy meter turn on

7. Meter power XXW shows positive means grid is supplying the load, and no power fed into grid. if meter power shows negative, it means PV energy is being sold to grid or energy meter wiring connection has problem.
8. After properly connection is done, wait for inverter starting. If the power of the PV array meets the current power consumption, the inverter will keep a certain output to counteract the power of the grid without backflow .

7.3 Notes while using zero export function

For your safety and the operation of limiter function of the inverter, we put forward the following suggestions and precautions:



Safety Hint:

Under zero export mode we strongly recommend that the two PV arrays are formed by the same number of PV panels of the same size, which will make the inverter more responsive to limit the power.



Safety Hint:

While the utility power is negative and inverter has no output power, that means the orientation of the current sensor is wrong, please turn off the inverter and change orientation of the current sensor.

7.4 How to browse the load power of your PV grid-tie plant on monitoring platform?

If you want to browse load power of the system and how much energy (KWH) does it export to grid (inverter output power is used to power the load firstly and then the surplus energy will feed into grid). You also need to connect the meter according to above diagram. After the connection completed successfully, the inverter will show the load power on the LCD. **But please don't setup "Meter ON"**. Also, you will be able to browse the load power on the monitoring platform. The plant setting method as below description.

Firstly, go to the solarman platform (<https://pro.solarmanpv.com>, this link is for solarman distributor account; or <https://home.solarmanpv.com>, this link is for solarman end user account;) plant home page and click "edit"

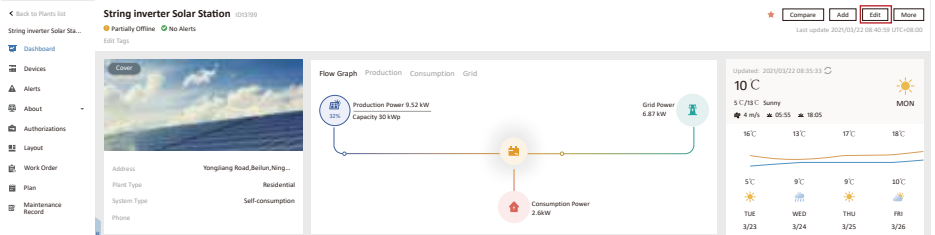

And then choose your system type as “Self-consumption”

Edit Plant Cancel Done

Basic Info
System Info
Yield Info
Owner Info

Address:

Coordinates:

Time Zone:

Creation Time: 2020/04/08

System Info Collapse

Plant Type:

System Type:

Capacity(kW):

Address:

Secondly, go to plant page, if it shows the PV power, load power and grid power, which means the configuration is correct.

String Inverter Solar Station (019399) Compare Add Edit Move
Last update: 2021/02/22 18:40:55 UTC+08:00

Partially Offline No Alerts

Dashboard

Devices

Alerts

About

Authorizations

Layout

Work Order

Plan

Maintenance Record

Close

Address: Yongliang Road,Beilun,Ning...

Plant Type: Residential

System Type: Self-consumption

Phone

Flow Graph Production Consumption Grid

Production Power 9.52 kW
Capacity 30 kWp

Grid Power 6.87 kW

Consumption Power 2.6kW

Updated: 2021/02/22 08:35:59

10°C

5°C, 79°C Sunny

4:49, 15:55, 18:05

MON

16°C 13°C 17°C 18°C

5°C 9°C 9°C 15°C

TUE WED THU FRI

3/23 3/24 3/25 3/26

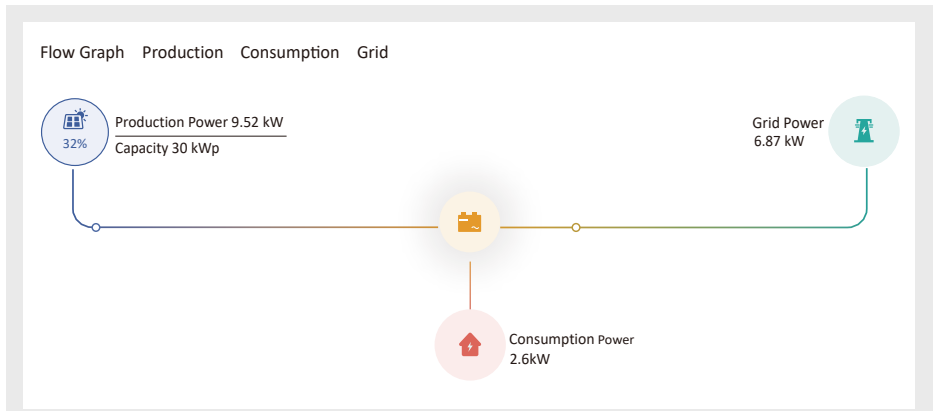

8. General Operation

During normal operation, the LCD shows the current status of the inverter, including the current power, total generation, a bar chart of power operation and inverter ID, etc. Press the Up key and the Down key to see the current DC voltage, DC current, AC voltage, AC current, inverter radiator temperature, software version number and Wifi connection state of the inverter.

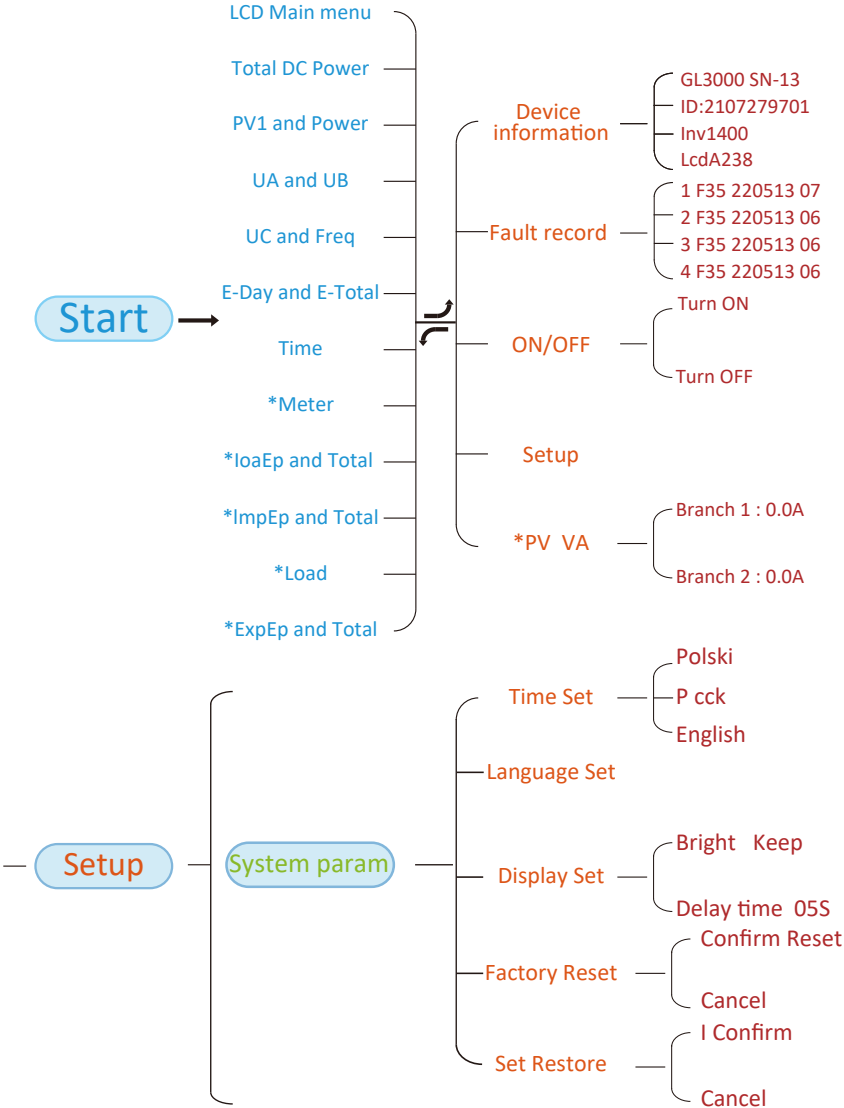

Setup

Running param

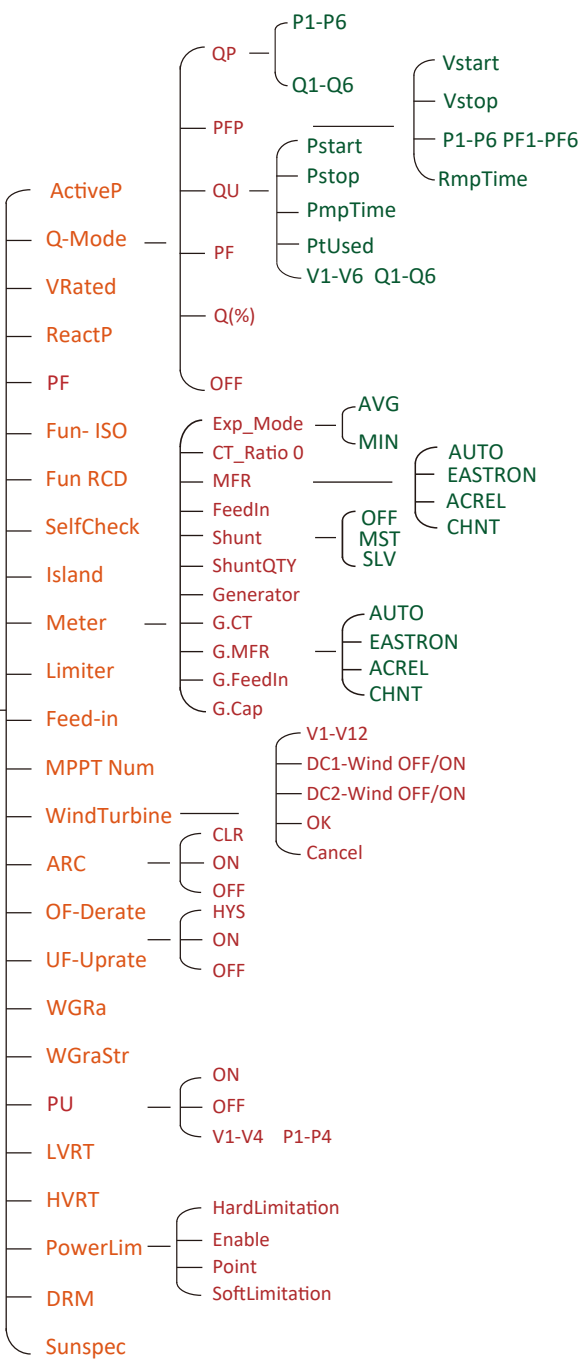

***Note: These parameters will be available after the meter is connected successfully. Otherwise, it won't show.**

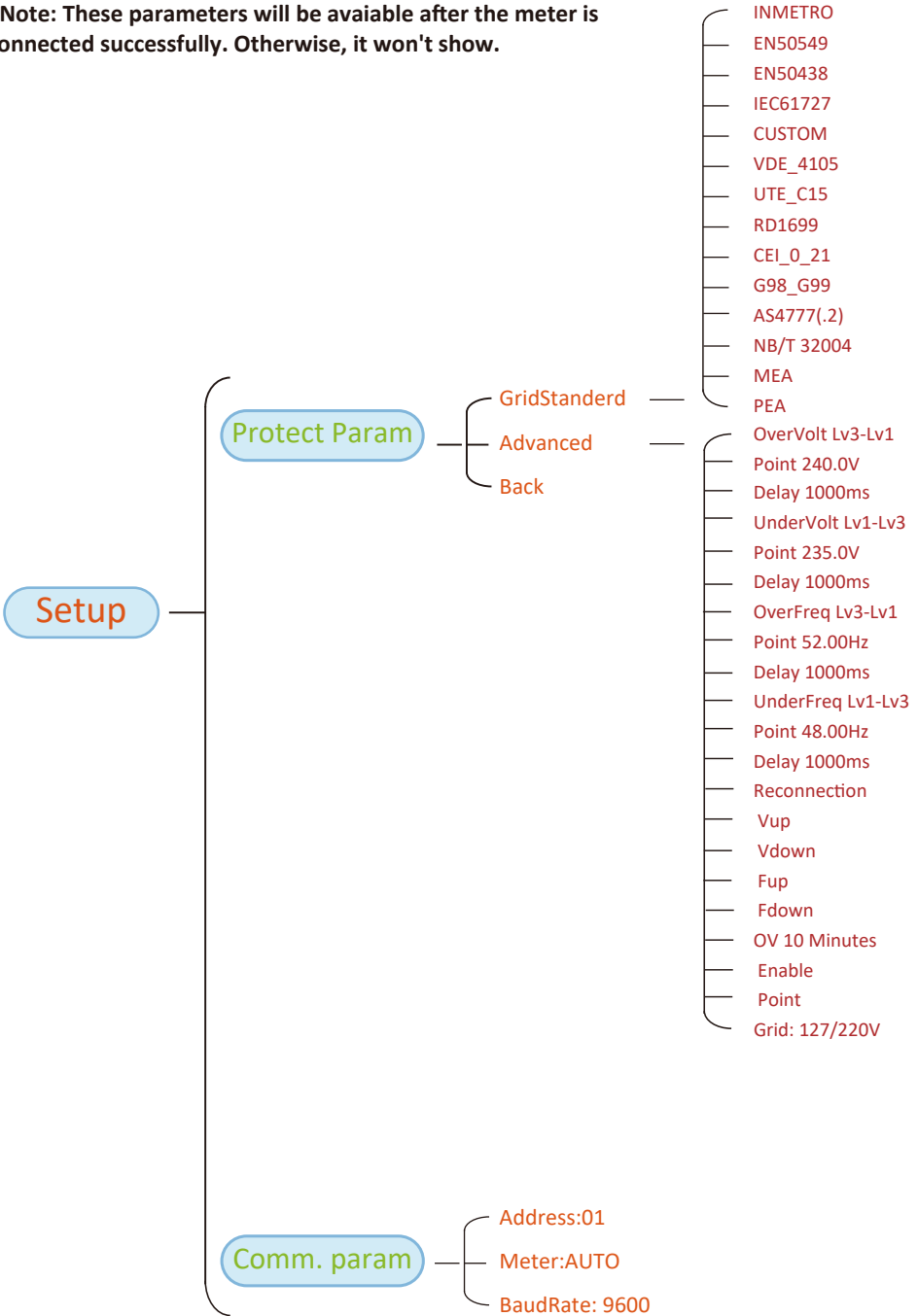

Pic 8.1 LCD operation flow chart

8.1 The initial interface

From the initial interface, you can check PV power, PV voltage, grid voltage, inverter ID, model and other information.



Pic 8.2 The initial interface

Press UP or Down, you can check inverter DC voltage, DC current, AC voltage, AC current and inverter temperature.



Pic 8.3 PV input voltage and current information

Pic 8.4 Load power



Pic 8.5 Grid voltage and current information

Pic 8.6 Grid voltage and frequency



Pic 8.7 PV generation

E-Day: Daily generation;
E-Total: Total generation.



Pic 8.8 Time



Pic 8.9 Meter power



Pic 8.10 Load consumption

LoadEp: Daily consumption;
Total: Total energy consumption.

```
ImpEp: 0.00KWh
Total : 0.00KWh
```

ImpEp: Daily energy purchased from grid;
Total: Total energy purchased from grid.

Pic 8.11 Electrical energy

```
ExpEp: 0.00KWh
Total : 0.00KWh
```

ExpEp: Daily energy sold to grid;
Total: Total energy sold to grid.

Pic 8.12 Electrical energy

8.2 Submenus in the Main Menu

There are five submenus in the Main Menu.

8.2.1 Device information

You can see the LCD software VerA238 and control board software Ver1400. In this interface, there are parameters such as rated power communication addresses.

<pre>Device Info. << Fault Record</pre>	<pre>GL3000 SN-13 ID:2107279701</pre>
<pre>ID:2107279701 Inv1400</pre>	<pre>Inv1400 LcdA238</pre>

Pic 8.13 Device information

8.2.2 Fault Record

It can keep Eight fault records in the menu including time, customer can deal with it depends on the error code.

<pre>Device Info. Fault Record <<</pre>	<pre>1 F35 220513 07 2 F35 220513 06</pre>
<pre>3 F35 220513 06 4 F35 220513 06</pre>	

Pic 8.14 Fault Record

8.2.3 ON/OFF setting



Pic 8.15 ON/OFF setting

When the inverter is turned off, it stops working immediately, and go to standby mode and then will go to self-test program again. If it passed the self-test, it will start to work again.

8.2.4 PV VA setting



Pic 8.16 PV String current

Each PV string current and this function is optional.

8.2.5 Parameter setting

There are five submenus in the setup. Setting includes system param, run param, protect param, comm: param. All of these information for maintenance reference.

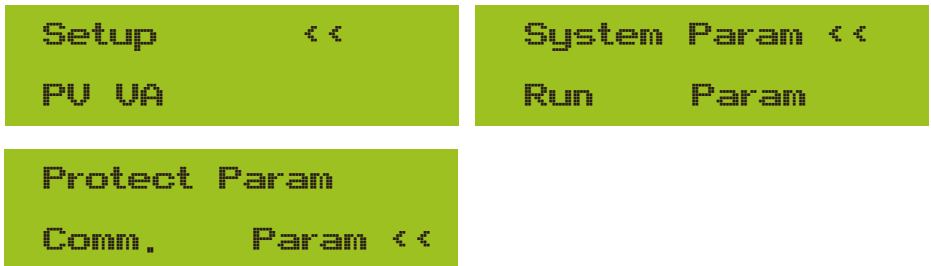

Pic 8.17 Submenus of the parameter setup

8.3 System param setting

System Param includes time set, language set, display set and factory reset.



Pic 8.18 System Param



Pic 8.19 Time



Pic 8.20 Language



Pic 8.21 LCD Screen settings



Pic 8.22 Delay time set



Pic 8.23 Reset to factory setting



Pic 8.24 Set Restore

8.4 Running param set



Warning:

Password required-- only for access-authorized engineer. Un-authorized access may avoid the warranty. The initial password is 1234.



Pic 8.25 Password



Pic 8.26

Name	Description	Range
ActiveP	Adjust the output active power in %	0-110%
Q-Mode	Multiple reactive power control modes	OFF/Q(P)/PF(P) /Q(U)/PF/Q(%)
Vref	Grid reference voltage for functions including Q(U),PF(P),P(U)etc.	80-260V
ReactP	Adjust reactive power output in %	-100%~+100%
PF	Power Fator	-1-0.8~+0.8-1
Fun_ISO	Insulation resistance detection	ON/OFF
Fun_RCD	Residual current detection	ON/OFF
Self-check	Inverter's self-check time.The default value 60s	0-1000s
Island	Anti-islanding protection	ON/OFF
Meter	If you want to use zero output mode,please set Meter to ON and select OFF to view data only	ON/OFF
Feed_IN %	It is used to deploy how much power can be feed in to grid when the inverter works under zero export mode.(For example, Feed_in=50% of the 8KW model and load power is 3KW. which means Max 4KW power can be feed into grid after inverter providing 3Kw to the load firstly.	0-100%

Pic 8.27

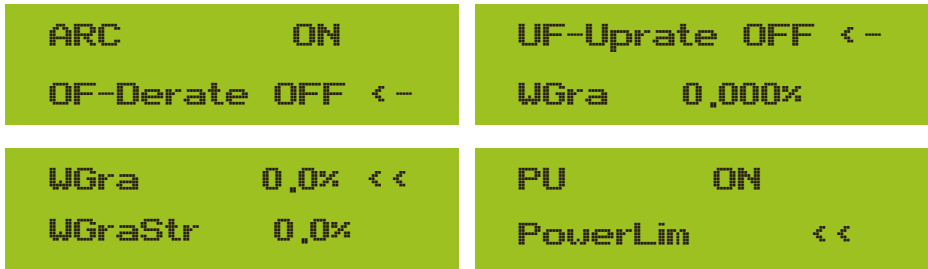

Pic 8.28

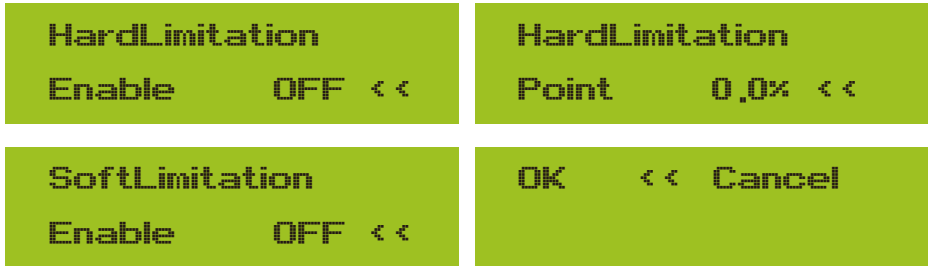

Pic 8.29



Pic 8.30

Name	Description	Range
ARC	Arc-fault detection function	ON/OFF/CLR
OF-Derate	Active power response to over-frequency	ON/OFF/HYS
UF-Uprate	Active power response to under-frequency	ON/OFF
PU	power response to grid voltage deviation	ON/OFF
LVRT	voltage ride through function	ON/OFF
HVRT	voltage ride through function	ON/OFF
PowerLim	Hard/soft export limit control	ON/OFF
DRM	Demand Response Modes	ON/OFF
Sunspec	Sunspec Function	ON/OFF
WGraStr	Percentage of Nominal Power per second	0.1%~10%
WGra	percentage of Nominal Power per second	0.1%~10%

Pic 8.31

Over-frequency Response

This series inverter provides “over-frequency response” function. Long pressing the “OFD Mode” to enter the “over-frequency response” setting menu.



Tab. 11-4 Definition of Over-frequency Response Parameters

Parameter	Range	Description
Fstr	45HZ-65HZ	The Start frequency value for over-frequency response.
Fstop	45HZ-65HZ	The Stop frequency value for over-frequency response.
RecPT	45HZ-65HZ	In hysteresis mode, power is restored only when it is below this frequency
RecGra	[3,500] 0.01%Pmax/s	Rate of Power recovery(Percentage of active power)

For example, StrtPT: 50.5Hz, StopPT: 51.5Hz, RecPT: 50.1Hz, when the grid frequency increases beyond Start: 50.5Hz, the inverter will linearly reduce the power output with a gradient of 100% Pmax/Hz until it reaches StopPT: 51.5Hz.

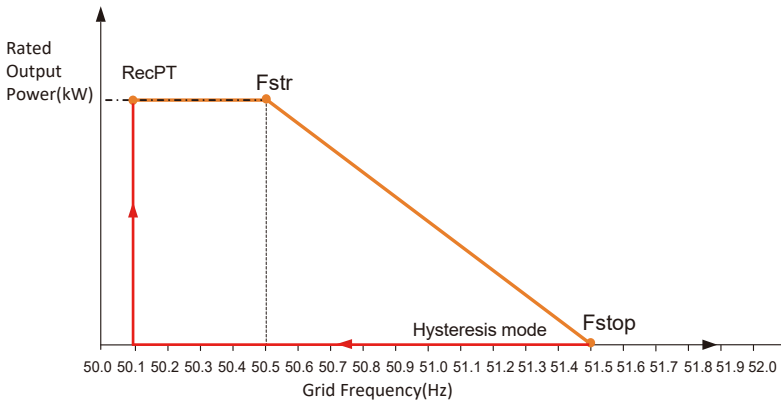

Fig. 11-3 Frq-Watt Mode for Over-frequency Conditions

When the frequency exceeds Fstop: 51.5Hz, the inverter output should stop (ie 0 W).
 When the frequency is lower than Fstop: 51.5 Hz, the inverter will linearly increase the power output with a gradient of 100% Pmax/Hz until it reaches Fstr: 50.5 Hz.
 In the hysteresis mode, when the frequency is lower than Fstop: 51.5 Hz, the inverter will not increase the power output until it is lower than RecPT: 50.1 Hz.



The inverter provides a reactive power regulation function.
 Tap **Reactive Power Regulation Mode** to select proper regulation mode and set the corresponding parameters.



Pic 8.32

- **"OFF" Mode**

The reactive power regulation function is disabled. The PF is fixed at +1.000

- **Q(%)**

Adjust reactive power output in %.

- **"PF" Mode**

The power factor (PF) is fixed and the reactive power is regulated by the parameter PF. The PF ranges from 0.8 leading to 0.8 lagging.

- Leading: the inverter is absorbing reactive power from the Grid.
- Lagging: the inverter is injecting reactive power into the grid.

- **"Q(U)" Mode**

The reactive power output of the inverter varies in response to the grid voltage.

- **"Q(P)" Mode**

The reactive power output by the inverter is controlled by the active power of the inverter.

- **"PF(P)" Mode**

The PF is controlled by the active power of the inverter.

"PU" Mode

The active power output of the inverter varies in response to the grid voltage

WGraStr 0,0%
PU OFF < -

WGraStr 0,0%
PU ON < -

U1 0,0% <<
P1 0,0%

U2 0,0% <<
P2 0,0%

U3 0,0% <<
P3 0,0%

U4 0,0% <<
P4 0,0%

OK Cancel <<

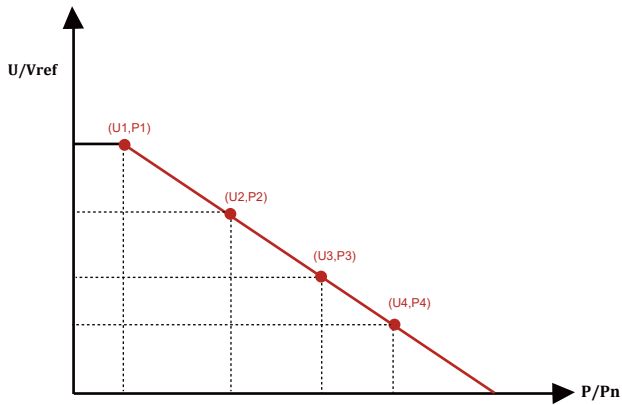

Pic 8.33 Active Power Regulation Curve in PU Curve

Parameter	Range	Description
P1	0%-110% Pn	Value of P/P_n at point (P1,U1) on the PU mode curve
U1	0% -150% Vref	Grid voltage limit at point (P1,U1) on the PU mode curve
P2	0%-110% Pn	Value of P/P_n at point (P2,U2) on the PU mode curve
U2	0% -150% Vref	Grid voltage limit at point (P2,U2) on the PU mode curve
P3	0%-110% Pn	Value of P/P_n at point (P3,U3) on the PU mode curve
U3	0% -150% Vref	Grid voltage limit at point (P3,U3) on the PU mode curve
P4	0%-110% Pn	Value of P/P_n at point (P4,U4) on the PU mode curve
U4	0% -150% Vref	Grid voltage limit at point (P4,U4) on the PU mode curve

"PU" Mode Parameters Explanation

“Q(U)” Mode

ActiveP	0%	Pstart	0,0% <<
QMode	Q(U) <-	Pstop	20,0%
RmpTime	0s	U1	0,0% <<
PtUsed	0 <<	Q1	0,0%
U2	0,0% <<	U3	0,0% <<
Q2	0,0%	Q3	0,0%
U4	0,0% <<	U5	0,0% <<
U4	0,0%	Q5	0,0%
U6	130,0% <<	Q6	0,0%
Q6	30,0%	OK	Cancel <<

Pic 8.34

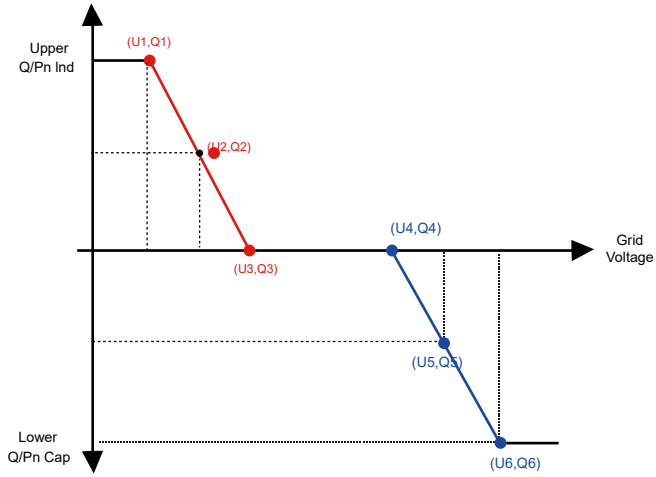

Pic 8.35 Reactive Power Regulation Curve in Q(U) Curve

Parameter	Range	Description
Pstart	0%-130% Rate out power	The QU mode starts when the active power is greater than this value
Pstop	0%-130% Rate out power	The QU mode stops when the active power is less than this value
Q1	-60% -60% Q/Pn	Value of Q/Pn at point (U1,Q1) on the Q(U) mode curve
V1	0-110% VRated	Grid voltage limit at point (U1,Q1) on the Q(U) mode curve
Q2	-60% -60% Q/Pn	Value of Q/Pn at point (U2,Q2) on the Q(U) mode curve
V2	0-110% VRated	Grid voltage limit at point (U2,Q2) on the Q(U) mode curve
Q3	-60% -60% Q/Pn	Value of Q/Pn at point (U3,Q3) on the Q(U) mode curve
V3	0-110% VRated	Grid voltage limit at point (U3,Q3) on the Q(U) mode curve
Q4	-60% -60% Q/Pn	Value of Q/Pn at point (U4,Q4) on the Q(U) mode curve
V4	0-110% VRated	Grid voltage limit at point (U4,Q4) on the Q(U) mode curve
Q5	-60% -60% Q/Pn	Value of Q/Pn at point (U5,Q5) on the Q(U) mode curve
V5	0-110% VRated	Grid voltage limit at point (U5,Q5) on the Q(U) mode curve
Q6	-60% -60% Q/Pn	Value of Q/Pn at point (U6,Q6) on the Q(U) mode curve
V6	0-110% VRated	Grid voltage limit at point (U6,Q6) on the Q(U) mode curve
RMpTime	0-1000s	Increase or decrease the time required for the reactive power to reach the specified value of the curve.

"Q(U)" Mode Parameters Explanation

“Q(P)” Mode

The reactive power output by the inverter is controlled by the active power of the inverter.

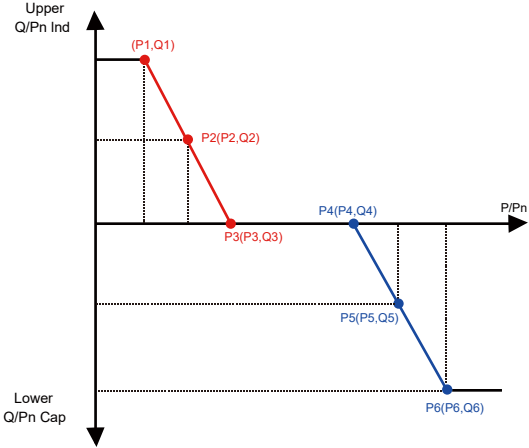

Pic 8.36 Reactive Power Regulation Curve in Q(P) Mode

ActiveP	20,0%	P1	0,0% <<
QMode	QP <-	Q1	0,0%
P2	0,0% <<	P3	0,0% <<
Q2	0,0%	Q3	0,0%
P4	0,0% <<	P5	0,0% <<
Q4	0,0%	Q5	0,0%
P6	0,0% <<	OK	<< Cancel
Q6	0,0%		

Parameter	Range	Description
P1	0%-100% P _n	Power value/P _n at point (P1,Q1) on the Q(P) mode curve
Q1	-60% -60% Q/P _n	Reactive power value at point (P1,Q1) on the Q(P) mode curve
P2	0%-100% P _n	Power value/P _n at point (P2,Q2) on the Q(P) mode curve
Q2	-60% -60% Q/P _n	Reactive power value at point (P2,Q2) on the Q(P) mode curve
P3	0%-100% P _n	Power value/P _n at point (P3,Q3) on the Q(P) mode curve
Q3	-60% -60% Q/P _n	Reactive power value at point (P3,Q3) on the Q(P) mode curve
P4	0%-100% P _n	Power value/P _n at point (P4,Q4) on the Q(P) mode curve
Q4	-60% -60% Q/P _n	Reactive power value at point (P4,Q4) on the Q(P) mode curve
P5	0%-100% P _n	Power value/P _n at point (P5,Q5) on the Q(P) mode curve
Q5	-60% -60% Q/P _n	Reactive power value at point (P5,Q5) on the Q(P) mode curve
P6	0%-100% P _n	Power value/P _n at point (P6,Q6) on the Q(P) mode curve
Q6	-60% -60% Q/P _n	Reactive power value at point (P6,Q6) on the Q(P) mode curve

"Q(P)" Mode Parameters Explanation

"PF(P)" Mode

The output power factor is controlled by the active power of the inverter.

Ustart	0,0%	P1	0,0%
Ustop	0,0%	PF1	-1,000 <<
P2	0,0%	P3	0,0%
PF2	-1,000 <<	PF3	-1,000 <<
P4	0,0%	P5	0,0%
PF4	-1,000 <<	PF5	-1,000 <<
P6	0,0%	RmpTime	0s
PF6	-1,000 <<	OK	Cancel <<

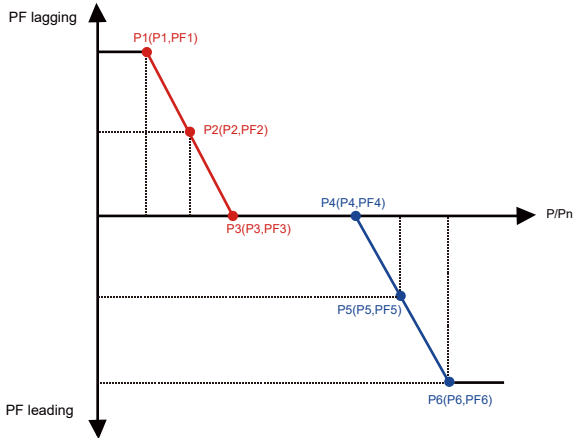

Pic 8.37 Power factor Regulation Curve in PF(P) Mode

Parameter	Range	Description
Vstart	0-150% Vref	The PFP mode is enable when grid voltage is greater than Vstart
Vstop	0-150% Vref	The PFP mode is disable when grid voltage is less than Vstop
P1	0-110% Pn	Power value at point (PF1,P1) on the PF(P) Curve
PF1	0.8 leading - 0.8 lagging	PF value at point (PF1,P1) on the PF(P) Curve
P2	0-110% Pn	Power value at point (PF2,P2) on the PF(P) Curve
PF2	0.8 leading - 0.8 lagging	PF value at point (P2,PF2) on the PF(P) Curve
P3	0-110% Pn	Power value at point (P3,PF3) on the PF(P) Curve
PF3	0.8 leading - 0.8 lagging	PF value at point (P3,PF3) on the PF(P) Curve
P4	0-110% Pn	Power value at point (P4,PF4) on the PF(P) Curve
PF4	0.8 leading - 0.8 lagging	PF value at point (P4,PF4) on the PF(P) Curve
P5	0-110% Pn	Power value at point (P5,PF5) on the PF(P) Curve
PF5	0.8 leading - 0.8 lagging	PF value at point (P5,PF5) on the PF(P) Curve
P6	0-110% Pn	Power value at point (P6,PF6) on the PF(P) Curve
PF6	0.8 leading - 0.8 lagging	PF value at point (P6,PF6) on the PF(P) Curve
RMpTime	0-1000s	The time of the PFF Curve in seconds (time to accomplish a change of 95%).

"PF(P)" Mode Parameters Explanation

8.5 Protect Param



Warning:

Engineer Only.

We will set the param depends on the safety requirements, so customers don't need to reset it. The password is same as 8.4 Running param



Pic 8.32 Password

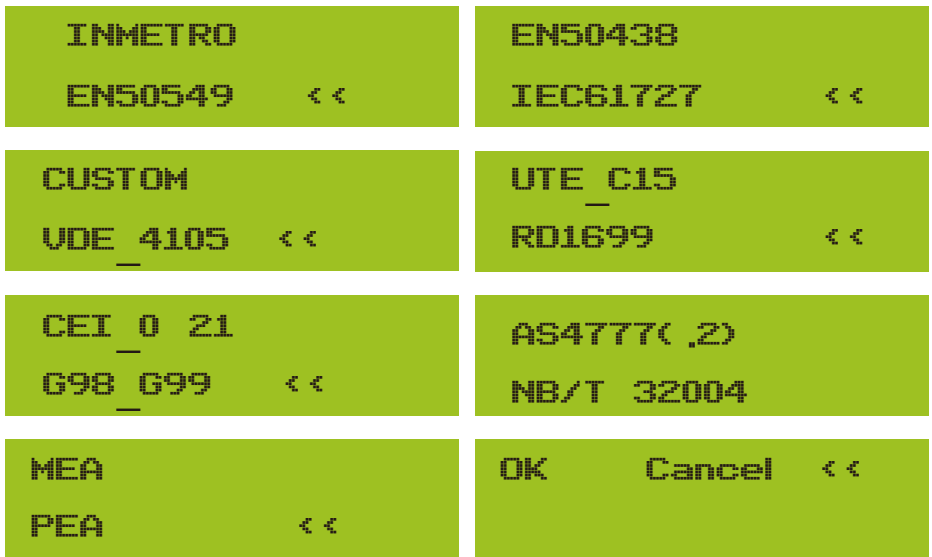

Warning:

Engineer only.



OverVolt Lv2
Point 240,0V <<

OverVolt Lv2
Delay 1000ms <<

OverVolt Lv1
Point 240,0V <<

OverVolt Lv1
Delay 1000ms <<

UnderVolt Lv1
Point 235,0V <<

UnderVolt Lv1
Delay 1000ms <<

UnderVolt Lv2
Point 235,0V <<

UnderVolt Lv2
Delay 1000ms <<

UnderVolt Lv3
Point 235,0V <<

UnderVolt Lv3
Delay 1000ms <<

OverFreq Lv3
Point 52,00Hz <<

OverFreq Lv3
Delay 1000ms <<

OverFreq Lv2
Point 52,00Hz <<

OverFreq Lv2
Delay 1000ms <<

OverFreq Lv1
Point 52,00Hz <<

OverFreq Lv1
Delay 1000ms <<

UnderFreq Lv1
Point 48,00Hz <<

UnderFreq Lv1
Delay 1000ms <<

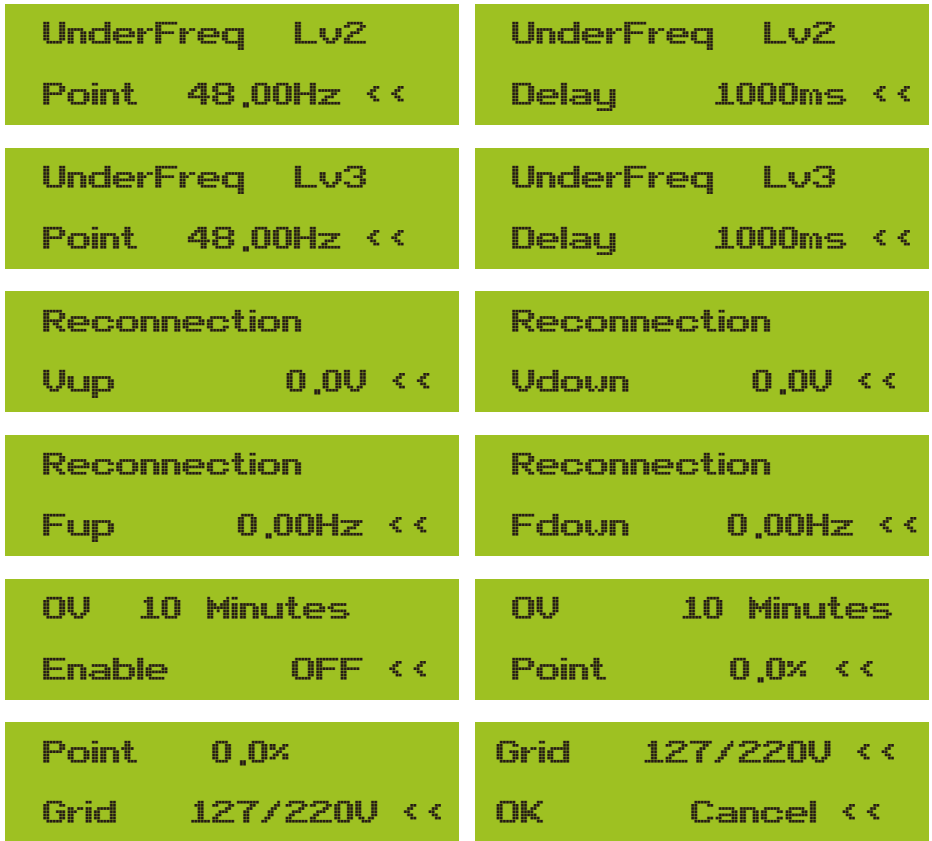

Pic 8.33 "CUSTOMIZED"

Please set the proper grid parameters according to the requirements of your current country's grid regulations. If you are not clear about it, please consult your installer.

8.6 Comm. param set



Pic 8.34 Comm. Param

9. Repair and Maintenance

String type inverter doesn't need regular maintenance. However, debris or dust will affect heat sink's thermal performance. It is better to clean it with a soft brush. If the surface is too dirty and affect the reading of LCD and LED lamp, you can use wet cloth to clean it up.



High Temperature Hazard:

When the device is running, the local temperature is too high and the touch can cause burns. Turn off the inverter and wait for it cooling, then you can clean and maintain.



Safety Hint:

No solvent, abrasive materials or corrosive materials can be used for cleaning any parts of the inverter.

10. Error information and processing

Inverter has been designed in accordance with international grid tied standards for safety, and electromagnetic compatibility requirements. Before delivering to the customer the inverter has been subjected to several tests to ensure its optimal operation and reliability.

10.1 Error code

If there is any failure, the LCD screen will display an alarm message. In this case, the inverter may stop feeding energy into the grid. The alarm description and their corresponding alarm messages are listed in Table 10.1.

Error code	Description	Ongrid - Three Phase
F01	DC input polarity reverse fault	Check the PV input polarity.
F02	DC insulation impedance permanent fault	Check the grounding cable of inverter.
F03	DC leakage current fault	Hardly appear the code. Never ever happened so far.
F04	Ground fault GFDI	Check the solar panel output connection.
F05	Read the memory error	Failure in reading memory (EEPROM). Restart the inverter if the fault still exists, contact your installer or Deye service.
F06	Write the memory error	Failure in writing memory (EEPROM). Restart the inverter if the fault still exists, contact your installer or Deye service.
F07	GFDI blown fuse	Hardly appear the code. Never ever happened so far.
F08	GFDI grounding touch failure	Hardly appear the code. Never ever happened so far.
F09	IGBT damaged by excessive drop voltage	Hardly appear the code. Never ever happened so far.
F10	Auxiliary switch power supply failure	1. It tells the DC 12V is not existed. 2. Restart the inverter, if the fault still exists, please contact your installer or Deye service.
F11	AC main contactor errors	Hardly appear the code. Never ever happened so far.
F12	AC auxiliary contactor errors	Hardly appear the code. Never ever happened so far.
F13	reserved	1. Loss of one phase or AC voltage detection part failure or relays not closed. 2. Restart the inverter, if the error still exists, please contact your installer or Deye service.
F14	DC firmware over current	Hardly appear the code. Never ever happened so far.
F15	AC firmware over current	1. The internal AC sensor or detection circuit on control board or connection wire may loose. 2. Restart the inverter, if the error still exists, please contact your installer or Deye service.
F16	GFCI(RCD) Ac leakage current fault	1. This fault means the average leakage current is over 300mA. Check whether DC power supply or solar panels is ok, then check 'Test data' -> 'diL' value is about 40; Then check the leakage current sensor or circuit (the following picture). Checking test data needs using big LCD. 2. Restart the inverter, if the error still exists, please contact your installer or Deye service.
F17	Three phase current, over-current fault	Hardly appear the code. Never ever happened so far.
F18	AC over current fault of hardware	1. Check AC sensor or detection circuit on control board or connection wire. 2. Restart the inverter or factory reset, if the error still exists, please contact your installer or Deye service.
F19	All hardware failure synthesis	Hardly appear the code. Never ever happened so far.

Error code	Description	Ongrid - Three Phase
F20	DC over current fault of the hardware	<ol style="list-style-type: none"> 1. Check whether solar panel output current is within the allowed range. 2. Check DC current sensor and its detection circuit. 3. Check if the inverter FW version is suitable for the hardware. 4. Restart the inverter, if the error still exists, please contact your installer or Deye service.
F21	DC leakage flow fault	Hardly appear the code. Never ever happened so far.
F22	Crash stop (if there is a stop button)	Contact your installer for help.
F23	AC leakage current is transient over current	<ol style="list-style-type: none"> 1. This fault means the leakage current is above 30mA suddenly. Check whether DC power supply or solar panels is ok, then check 'Test data'-> 'dil' value is about 40; Then check the leakage current sensor or circuit. Check test data needs using big LCD. 2. Restart the inverter, if the fault still exists, contact your installer or Deye service.
F24	DC insulation impedance failure	<ol style="list-style-type: none"> 1. Check Vpe resistance on main board or detection on control board. Check PV panels is OK. Many times this issue is the PV problem. 2. Check whether the PV panel (aluminum frame) is grounded well and inverter is grounded well. Open the cover of inverter and then check the inside ground cable is fixed well on the shell. 3. Check if the AC/DC cable, terminal block are shorted to ground or the insulation is damaged. 4. Restart the inverter, if the fault still exists, contact your installer or Deye service.
F25	DC feedback fault	Hardly appear the code. Never ever happened so far.
F26	The DC busbar is unbalanced	<ol style="list-style-type: none"> 1. Check whether the 'BUSN' cable or driver board power supply cable is loose. 2. Restart the inverter, if the fault still exists, contact your installer or Deye service.
F27	DC end insulation error	Hardly appear the code. Never ever happened so far.
F28	Inverter 1 DC high fault	Hardly appear the code. Never ever happened so far.
F29	AC load switch failure	Hardly appear the code. Never ever happened so far.
F30	AC main contactor failure	<ol style="list-style-type: none"> 1. Check relays and AC voltage of relays. 2. Check relays driver circuit. Check if the software is not suitable for this inverter. (Old inverter not have relays detection function) 3. Restart the inverter, if the fault still exists, contact your installer or Deye service.
F31	Relay open circuit fault	<ol style="list-style-type: none"> 1. At least one Relay can't be closed. Check relays and its driver signal. (Old inverter not have relays detection function) 2. Restart the inverter, if the fault still exists, contact your installer or Deye service.
F32	Inverter 2 dc high fault	Hardly appear the code. Never ever happened so far.
F33	AC over current	Hardly appear the code. Never ever happened so far.
F34	AC current over load	Hardly appear the code. Never ever happened so far.
F35	No AC grid	<ol style="list-style-type: none"> 1. Check AC grid voltage. Check AC voltage detection circuit. Check if the AC connector in good condition. Check whether the AC grid is normal in voltage. 2. Restart the inverter, if the fault still exists, contact your installer or Deye service.

Error code	Description	Ongrid - Three Phase
F36	AC grid phase error	Hardly appear the code. Never ever happened so far.
F37	AC three-phase voltage unbalance failure	Hardly appear the code. Never ever happened so far.
F38	AC three-phase current unbalance failure	Hardly appear the code. Never ever happened so far.
F39	AC over current(one cycle)	1. Check AC current sensor and its circuit. 2. Restart the inverter, if the fault still exists, contact your installer or Deye service.
F40	DC over current	Hardly appear the code. Never ever happened so far.
F41	AC Line W,U over voltage	Check the AC voltage protection setting. And Check if the AC cable is too thin.Check the voltage difference between LCD and meter.
F42	AC Line W,U low voltage	Check the AC voltage protection setting. Check the voltage difference between LCD and meter. Also need to check whether AC cables are all firmly and correctly connected.
F43	AC Line V,W over voltage	Check the AC voltage protection setting.And Check if the AC cable is too thin.Check the voltage difference between LCD and meter.
F44	AC Line V,W low voltage	Check the AC voltage protection setting. Check the voltage difference between LCD and meter. Also need to check whether AC cables are all firmly and correctly connected.
F45	AC Line U,V over voltage	Check the AC voltage protection setting.And Check if the AC cable is too thin.Check the voltage difference between LCD and meter.
F46	AC Line U,V low voltage	Check the AC voltage protection setting.
F47	AC Over frequency	Check the frequency protection setting.
F48	AC lower frequency	Check the frequency protection setting.
F49	U phase grid current DC component over current	Hardly appear the code. Never ever happened so far.
F50	V phase grid current DC component over current	Hardly appear the code. Never ever happened so far.
F51	W phase grid current DC component over current	Hardly appear the code. Never ever happened so far.
F52	AC inductor A, phase current DC current high	Hardly appear the code. Never ever happened so far.
F53	AC inductor B, phase current DC current high	Hardly appear the code. Never ever happened so far.
F54	AC inductor C, phase current DC current high	Hardly appear the code. Never ever happened so far.
F55	DC busbar voltage is too high	1. Check PV voltage and Ubus voltage and its detection circuit. If the PV input voltage exceeds the limit, please reduce the number of solar panels in series. 2. For Ubus voltage, please check the LCD display.

Error code	Description	Ongrid - Three Phase
F56	DC busbar voltage is too low	<ol style="list-style-type: none"> 1. It tells the PV input voltage is low and it always happens in the early morning. 2. Check PV voltage and Ubus voltage. When inverter is running, then showing F56, maybe Loss of driver or need update firmware. 3. Restart the inverter, if the fault still exists, contact your installer or Deye service.
F57	AC reverse irrigation	AC reverse irrigation.
F58	AC grid U over current	Hardly appear the code. Never ever happened so far.
F59	AC grid V over current	Hardly appear the code. Never ever happened so far.
F60	AC grid W over current	Hardly appear the code. Never ever happened so far.
F61	Reactor A phase over current	Hardly appear the code. Never ever happened so far.
F62	Reactor B phase over current	Hardly appear the code. Never ever happened so far.
F63	ARC fault	<ol style="list-style-type: none"> 1. Check PV module cable connection and clear the fault; 2. Seek help from us, if can not go back to normal state.
F64	IGBT heat sink high temperature	<ol style="list-style-type: none"> 1. Check temperature sensor. Check if firmware is suitable for the hardware. Check if the inverter is its right model. 2. Restart the inverter, if the fault still exists, contact your installer or Deye service.

Table10.1 Error codes and their solutions



Safety Hint:

If your string inverter has any of the fault information shown in Table 10-1, and when you reset the machine and still don't solve the problem, please contact our distributor and provide the below details:

1. Serial number of the inverter;
2. The distributor/dealer of the inverter(if available);
3. Installation date;
4. The discription of problem(include LCD'error code and LED status indicator lights);
5. Your contact details.

11.Specification

<i>Model</i>	<i>SUN-8K-G03-LV</i>
Input Side	
Max.DC Power(kW)	10.4
Max.DC Input Voltage(V)	800
Start-up DC Input Voltage(V)	250
MPPT Operating Range(V)	200~700
Max.DC Input Current(A)	13+26
Max. Short Circuit Current (A)	19.5+39
Number of MPPT/Strings per MPPT	2/1+2
MAX inverter backfeed current (A)	0
Output Side	
Rated Output Power(kW)	8
Max.Active Power(kW)	8.8
Rated AC Grid Voltage(V)	3L/N/PE 127/220V
AC Grid Voltage Range(V)	0.85Un-1.1Un (this may vary with grid standards)
Rated Grid Frequency(Hz)	50 / 60 (Optional)
Operating Phase	Three phase
Rated AC Grid Output Current(A)	21
Max.AC Output Current(A)	23.1
Maximum output fault current (a.c. A, peak)	40.1
Maximum output overcurrent protection (a.c. A,peak)	44.5
Output Power Factor	0.8 leading~0.8 lagging
Grid Current THD	<3%
DC Injection Current(mA)	<0.5%
Grid Frequency Range	47-52 or 57-62 (Optional)
Efficiency	
Max.Efficiency	98.5%
Euro Efficiency	97.5%
MPPT Efficiency	>99%
General Data	
Size(mm, W×H×D)	333×472×202
Weight(kg)	15
Topology	Transformerless
Internal consumption	<1W (Night)
Operating temperature	-25 ~ 65 °C ,>45 °C derating
Ingress protection	IP65
Noise Emission(Typical)	≤40dB
Cooling Concept	Smart cooling
Max. operation altitude	2000m
Designed Lifetime	>20 Years
Grid Connection Standard	VDE4105, IEC61727/62116, VDE0126, AS4777.2, CEI 0 21, EN50549-1, G98, G99, C10-11, UNE217002, NBR16149/NBR16150
Operation surrounding humidity	0~100%
Safety EMC / Standard	IEC/EN 61000-6-1/2/3/4, IEC/EN 62109-1, IEC/EN 62109-2

General Data

DC Connection	MC-4 mateable
AC Connection	IP65 rated plug
Display	LCD1602
Interface	RS485/RS232/Wifi/LAN

2022-12-22 Ver 2.3

NINGBO DEYE INVERTER TECHNOLOGY CO., LTD.

Add: No.26-30, South Yongjiang Road, Beilun, 315806, Ningbo, China

Tel: +86 (0) 574 8622 8957

Fax: +86 (0) 574 8622 8852

E-mail: service@deye.com.cn

Web: www.deyeinverter.com



30240301001081