

DDSU666 Single-phase electronic type guide
rail mounting electric energy meter

User manual

ZTY0.464.922

Zhejiang CHINT Instrument&Meter Co.,Ltd

March , 2016

Directory

1. Summarize	1
2. The overall principle block-diagram.....	2
3. The major specifications and parameter	3
4. Main functions	5
5. Externa and installation dimension.....	11
6. Installation and instructions for use	11
7. Diagnosis, analysis and troubleshooting of common faults	12
8. Packge, transportation and storage	13
9. Mantenance and repair	13
Appendix A MODBUS-RTU Communication protocol	14

DDSU666 Single-phase electronic type guide rail mounting electric energy meter	ZTY0.464.922
User manual	Total 20 Page 1

1. Summarize

1.1 The main purpose and the suitable occasion

DDSU666 Single-phase electronic type guide rail mounting electric energy meter(Hereinafter referred to as "the instrument") is designed for power monitoring and energy metering demand of the electric power system, communication industry, and construction industry. It is a new generation of intelligent instruments, integrated Communication and Measurement, mainly used as measurement and display of voltage and current, power, frequency, power factor and active power in electrical circuit. It will realize the data network of external devices by RS485 communication. It uses standard DIN35mm rail mounting structure, modular design. It has the advantages of small size, easy installation and easy networking .It is used widely as energy monitoring and assessment in industrial and mining enterprises, hotels, schools, and large public buildings.

Conform to the following standards:

IEC 61010-1:2010 《Safety requirements for electrical requirement for measurement, control, and laboratory use Part1:General requirements》

IEC 61326-1:2013 《Electrical requirement for measurement, control and laboratory use –EMC requirements Part1:General requirements》

1.2 Product features

- 1) It measures the positive and negative electric energy, and the negative electric energy is added up as the positive(Not as the basis for billing, for reference);
- 2) Use wide temperature LCD;
- 3) Use standard DIN35mm rail mounting structure, modular design. It has the advantages of small size, easy installation and easy networking.

					资料来源	编制	<<设计签字>>	<<设计签字日期>>
						校对	<<校对签字>>	<<校对签字日期>>
						审核	<<审核签字>>	<<审核签字日期>>
						标准化	<<标准化签字>>	<<标准化签字日期>>
					提出部门	审定	<<审定签字>>	<<审定签字日期>>
						批准	<<批准签字>>	<<批准签字日期>>
标记	处数	更改文件号	签字	日期		职责	签字	日期

DDSU666 Single-phase electronic type guide rail mounting electric energy meter	ZTY0.464.922
User manual	Total 20 Page 2

1.3 Model composition and significance

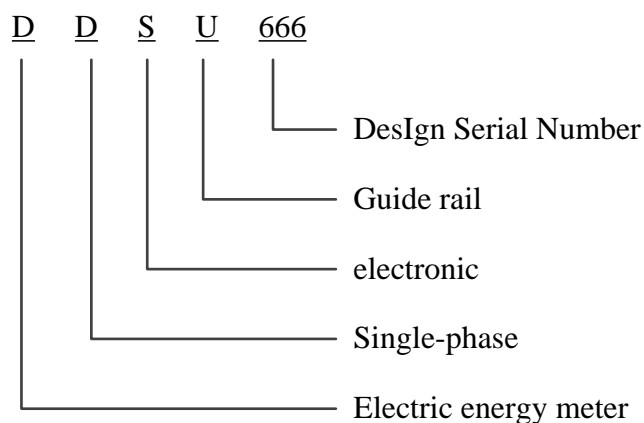

1.4 Environmental conditions

Rated temperature: $-25^{\circ}\text{C} \sim +55^{\circ}\text{C}$;

Limit temperature : $-40^{\circ}\text{C} \sim +70^{\circ}\text{C}$;

Relative humidity(average annual): $\leq 75\%$;

Atmosphere: 86kPa \sim 106kPa.

2. The overall principle block-diagram

The follow figure 1 is the overall principle block-diagram of the instrument.

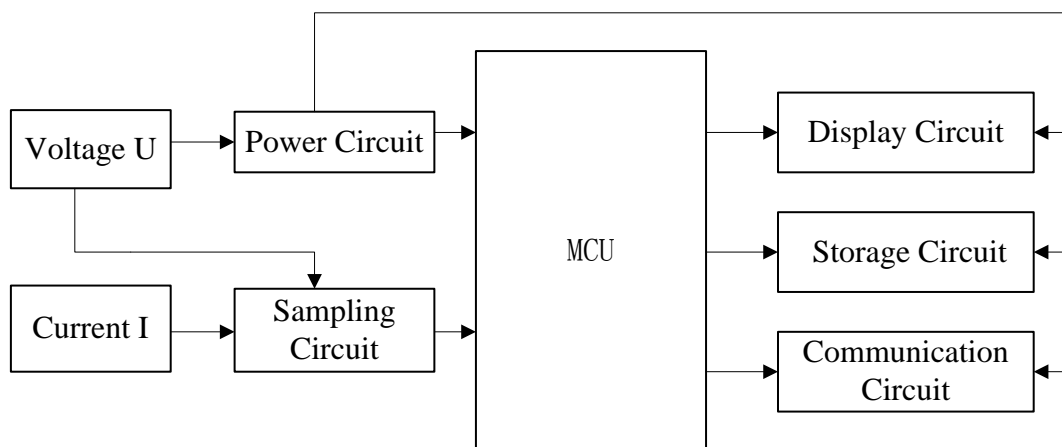

Figure 1 the overall principle block-diagram

DDSU666 Single-phase electronic type guide rail mounting electric energy meter	ZTY0.464.922
User manual	Total 20 Page 3

3. The major specifications and parameter

3.1 types and specifications

model numbers	accuracy grade	frequency	Reference voltage	current rating	constant	type
DDSU666	Active power 1	50Hz/60Hz	230 V	5(60)A	800imp/kWh	direct access meter
DDSU666	Active power 1	50Hz/60Hz	230 V	*/100mA	800imp/kWh	Mutual inductance access

*Note: in order to prevail in kind

3.2 Percentage error

The percentage error of single-phase electric meter shall not exceed the following limit value.

Current value		power factor	Percent error limit of Each level meter	
direct access meter	Connected with electronic transformers		1	2
$0.05 I_b \leq I < 0.1 I_b$	$0.02 I_n \leq I < 0.05 I_n$	1	±1.5	±2.5
$0.1 I_b \leq I \leq I_{max}$	$0.05 I_n \leq I \leq I_{max}$	1	±1.0	±2.0
$0.1 I_b \leq I < 0.2 I_b$	$0.05 I_n \leq I < 0.1 I_n$	0.5L	±1.5	±2.5
		0.8C	±1.5	--
$0.2 I_b \leq I \leq I_{max}$	$0.1 I_n \leq I \leq I_{max}$	0.5L	±1.0	±2.0
		0.8C	±1.0	--
The user's special requirements		0.25L	±3.5	--
$0.2 I_b \leq I \leq I_{max}$	$0.1 I_n \leq I \leq I_{max}$	0.5C	±2.5	--

DDSU666 Single-phase electronic type guide rail mounting electric energy meter	ZTY0.464.922
User manual	Total 20 Page 4

3.3 Start

Under the condition of reference voltage and table 4, the electric meter can start and continuously measure the electric energy.

instrument	grade of electric meter		power factor
	1 grade	2 grade	
direct access meter	$0.004I_b$	$0.005I_b$	1
Connected with electronic transformers	$0.002I_n$	$0.003I_n$	

3.4 Creeping

The meter should have good anti creeping logic, when the voltage loop is applied with 1.15 times reference voltage and current circuit is open, the meter will not produce more than 1 pulse.

3.5 Electrical parameters

Specified operating voltage range	$0.9U_n \sim 1.1U_n$
Extended operating voltage range	$0.7U_n \sim 1.2U_n$
Limiting operating voltage range	$0 U_n \sim 1.9U_n$
Voltage line power consumption	$\leq 2W/10VA$
Current line power consumption	$\leq 2.5VA$

3.6 Other technical parameters

Range of measurement	0 ~ 999999.99 kWh (Only show 6 bits, decimal shift automatically)
Display mode	LCD
Communication protocol	DL/T 645-2007 (default) Modbus-RTU

3.7 Key parts and components

Metering chip: HT5019

Pressure sensitive resistance: 14K681

crystal oscillator: 32.768KHz

DDSU666 Single-phase electronic type guide rail mounting electric energy meter	ZTY0.464.922
User manual	Total 20 Page 5

Power transformer: ZTY6.170.234

Printed circuit board: ZTY8.067.1930, ZTY8.067.1931, ZTY8.067.1932, ZTY8.067.1933.

4. Main functions

4.1 Metering function(Not as the basis for billing, for reference)

It measures the positive and negative electric energy, and the negative electric energy is added up as the positive

After power off, the stored data would not be lost.

4.1 Display function

When working in normal condition (load condition), the positive pulse indicator light should be flashing. If there is no flicker or light for a long time, please check the wiring.







Meaning of liquid crystal identification

Notations	Meaning
V	A unit of voltage, Meaning that LCD shows the voltage data
A	A unit of current, Meaning that LCD shows the current data
W	A unit of power, Meaning that LCD shows the power data
var	A unit of Reactive power, Meaning that LCD shows the Reactive power data
Hz	A unit of frequency, Meaning that LCD shows the frequency data
kWh	A unit of Active electric energy, Meaning that LCD shows the Active electric energy data
kvarh	A unit of Reactive power, Meaning that LCD shows the Reactive power data



DDSU666 Single-phase electronic type guide rail mounting electric energy meter	ZTY0.464.922
User manual	Total 20 Page 6

The measurement data pages display per 5 seconds, and the pages as follows. (if the instrument panel is not the same, depend on the actual model).

Display instructions

PageS	Content	instruction
Page1		Meaning that the meter is showing the voltage, the unit is 'V', The picture left shows : U=220.0V.
Page2		Meaning that the meter is showing the current, the unit is 'A', The picture left shows : I=5.000V.
Page3		Meaning that the meter is showing the active power, the unit is 'W', The picture left shows : P=0.0 W.
Page4		Meaning that the meter is showing the active energy, the unit is 'A', The picture left shows : Imp=0000.50kWh.
Page5		Meaning that the meter is showing the 645 communication protocol

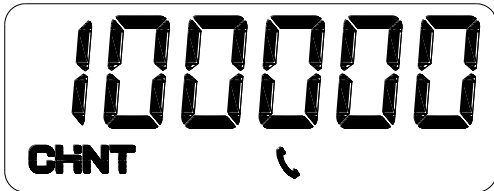
DDSU666 Single-phase electronic type guide rail mounting electric energy meter	ZTY0.464.922
User manual	Total 20 Page 7

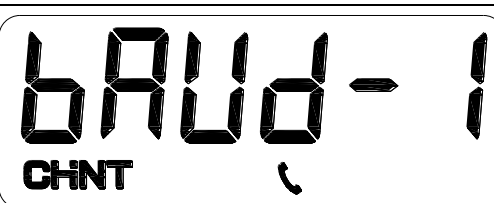
Page6		Meaning that the current 645 address is 100000000011
Page7		
Page8		Meaning that the baud rate is 2400

4.2 Communication function

The instrument adopts RS485 communication mode, the baud rate can be set to 1200, 2400bps, 4800bps, 9600bps.

The communication line can be connected up to 32 meters at the same time, and the address of each meter can be set. Communication connections should use Copper mesh shielded twisted pair and the diameter would not be less than 0.5mm². Wire the communication line distance from the power cable or other strong electric field, the maximum transmission distance is 1200m, the typical network connection is shown in the follow figure, and the user can object other suitable connection in accordance with specific conditions.

DDSU666 Single-phase electronic type guide rail mounting electric energy meter	ZTY0.464.922
User manual	Total 20 Page 8

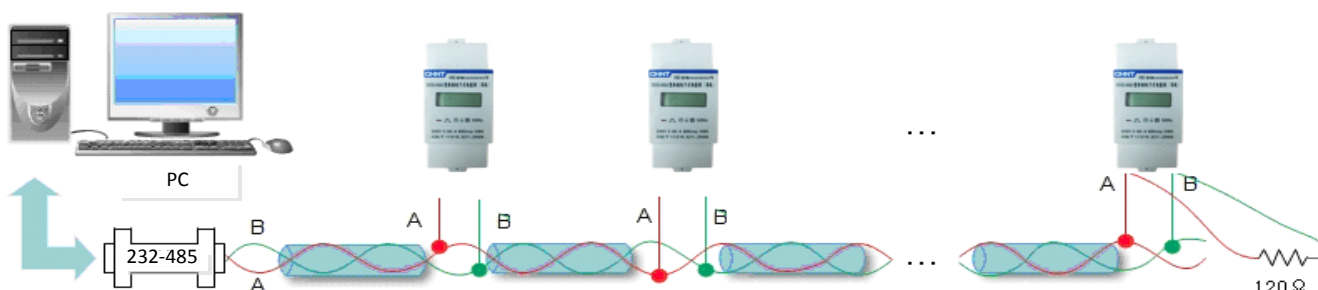

Figure 2 the typical network connection

When the instrument is set DL/T 645-2007 transmission mode, the instrument must measure up to the relevant stipulate in DL/T 645-2007. Pay attention to read data: electric energy data support power total; variable data support the voltage and current, instantaneous active and reactive power and power factor; support address settings, and the detail protocols are in DL/T 645-2007.

When DL/T 645-2007 protocol is changed to the ModBus-RTU protocol, the data frame is as follows:

FE FE FE FE 68 xx xx xx xx xx xx 68 14 0E 33 33 35 3D 35 33 33 33 33 33 33 33 33 CS 16

Parameter address	Parameter code	Instruction of the parameters	Type of data	Length of data Word	Read&write attributes
0000H	UCode	Programming password code	16-bit with symbols	1	R/W
0001H	REV.	Reserved, actual read is the version number	16-bit with symbols	1	R
0002H	ClrE	Electric energy zero clearing CLr.E(1:zero clearing)	16-bit with symbols	1	R/W
0003H	RESERVED	RESERVED	16-bit with symbols	1	

DDSU666 Single-phase electronic type guide rail mounting electric energy meter	ZTY0.464.922
User manual	Total 20 Page 9

0004H	RESERVED	RESERVED	16-bit with symbols	1	
0005H	ChangeProtocol	Protocol changing-over	16-bit with symbols	1	R/W
0006H	Addr	Communication address Addr	16-bit with symbols	1	R/W
0007H	RESERVED	RESERVED	16-bit with symbols	1	
0008H	RESERVED	RESERVED	16-bit with symbols	1	
0009H	RESERVED	RESERVED	16-bit with symbols	1	
000AH	RESERVED	RESERVED	16-bit with symbols	1	
000BH	Meter type	Meter type	16-bit with symbols	1	R
000CH	BAud	Communication baud rate bAud	16-bit with symbols	1	R/W
000DH	RESERVED	RESERVED	16-bit with symbols	1	
000EH	RESERVED	RESERVED	16-bit with symbols	1	
000FH	RESERVED	RESERVED	16-bit with symbols	1	
0010H	RESERVED	RESERVED	16-bit with symbols	1	
Electric quantity of the secondary side					
2000H	U	Voltage	single precision floating decimal	2	R
2002H	I	Current	single precision floating decimal	2	R
2004H	P	Conjunction active power , the unit is KW	single precision floating decimal	2	R
2006H	Q	Conjunction reactive power , the unit is Kvar	single precision floating decimal	2	R
2008H	RESERVED	RESERVED	single precision floating decimal	2	R
200AH	PF	Conjunction power factor	single precision floating decimal	2	R

DDSU666 Single-phase electronic type guide rail mounting electric energy meter	ZTY0.464.922
User manual	Total 20 Page 10

200CH	RESERVED	RESERVED	single precision floating decimal	2	R
200EH	Freq	Frequency	single precision floating decimal	2	R
2010H	RESERVED	RESERVED	single precision floating decimal	2	R
Electrical data of the secondary side					
4000H	Ep	Active in electricity	single precision floating decimal	2	R
400AH	-Ep	Reverse in electricity	single precision floating decimal	2	R

Note: XX XX XX XX XX is the table communication address; CS is the check code

When the instrument is set to the ModBus-RTU transmission mode, the ModBus-RTU communication protocol uses a master-slave mode to communicate in a communication line. First, the signal of the host computer is addressed to a single address terminal device (slave), and then the response signal from the terminal device is transmitted to the host in the opposite direction, i.e., half duplex mode of operation. The agreement is only allowed in the host (PC, PLC) and the communication between the terminal equipment between the terminal equipment and does not allow the independent data exchange, so that the terminal equipment does not occupy the communication line in their initialization, but only to query the machine response signal.

The instrument provides the ModBus-RTU communication protocol (see Appendix A), the communication can read or modify the parameter information, see the following table.

Table 3 Communication parameter information

DDSU666 Single-phase electronic type guide rail mounting electric energy meter	ZTY0.464.922
User manual	Total 20 Page 11

Change Protocol: Protocol switch mode word, when the data is 2, the protocol is Modbus-RTU protocol, when the data is 1, the protocol is DL/T 645-2007 protocol;

CLr.E: electric energy cleared, when write 1 will clear the total electric energy;

BAud: 0:1200bps; 1:2400bps; 2:4800bps; 3:9600bps.

4.3 Output function

The electric energy pulse output interface of the meter is a passive photoelectric isolated output, and the output pulse waveform is 80 + 16ms square wave.

Meter pulse indication uses long life led display.

5. Externa and installation dimension

Externa dimension: 36mmx89mmx74mm; Installation dimension: 35mm.

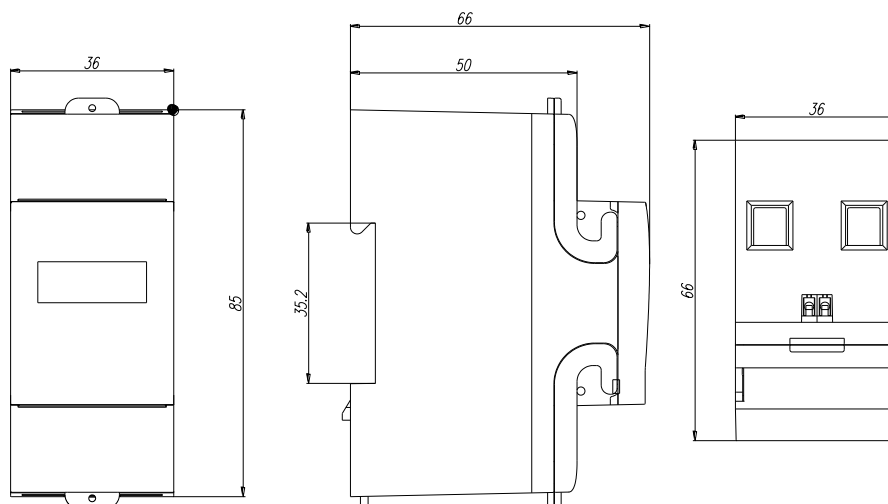

Figure 3 Outline and installation dimension

6. Installation and instructions for use

6.1 Check

- 1) Before installation, please check whether the model and specifications of the products on the box are in line with the material, if not, please contact the supplier;
- 2) Check the packing case of the product is damaged, if damaged, please contact the supplier.

6.2 Install

Stuck the instrument on the guide rail directly, and install the instrument and the rail in the distribution box finally.

DDSU666 Single-phase electronic type guide rail mounting electric energy meter	ZTY0.464.922
User manual	Total 20 Page 12

- 1) when installed, stuck the end of the card slot in the guide rail.
- 2) when uninstalled, use a screwdriver to press the card to remove the instrument

6.3 Connection

6.3.1 Terminal description

Prior to power up, check the wiring is correct, wiring diagram is as follow:

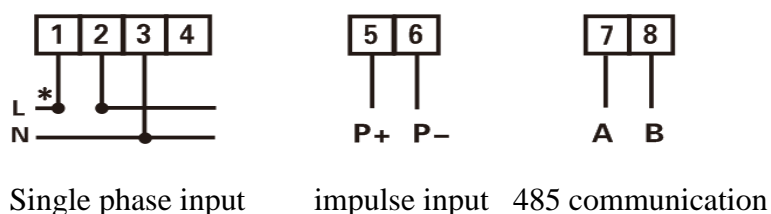

Direct access to the instrument

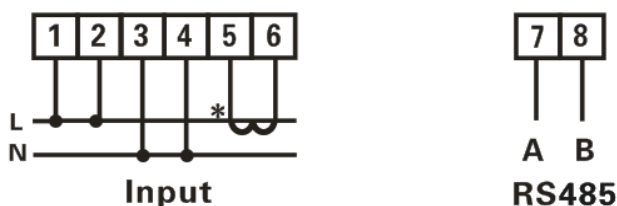

Mutual inductance access to the instrument

Figure 4 wiring diagram

7. Diagnosis, analysis and troubleshooting of common faults

7.1 Display fault

- (1) Check up: Dose the actual wiring accord with wiring requirements, actually the positon of 'N'.
- (2) Measure: If the connection is no problem, check up the external line related using a multi-meter to make sure the wiring terminal and diverter is conducting.

Note: when checking up the current and voltage lines, we must ensure that the signal current and voltage is in the open state, to ensure personal safety.

7.2 Communication failure

- (1) Check up: Check up the communication settings are the same as the PC, such as address, baud

DDSU666 Single-phase electronic type guide rail mounting electric energy meter	ZTY0.464.922
User manual	Total 20 Page 13

rate, and parity.

If the above methods can't remove failures, please contact the Zhejiang CHINT Instrument Co., Ltd..

8. Package, transportation and storage

The package of the meter should use the material which can meet environmental requirements. The storage environment temperature is $-40^{\circ}\text{C} \sim 70^{\circ}\text{C}$, relative humidity should be no more than 75%.

The package should meet the standards in GB/T 13384-2008, Conventional storage and transportation environment should meet the standards in GB/T 25480-2010.

A complete set of packaging products, including follows:

- 1) A meter
- 2) A user manual
- 3) A packet of desiccant
- 4) Certificate

9. Maintenance and repair

If users find any quality problem within 18 months from the date of dispatch, our company is responsible for repairing or replacing for free, on the condition that users operate according to the manual's provision with correct operation and the factory's seal is complete.

DDSU666 Single-phase electronic type guide rail mounting electric energy meter	ZTY0.464.922
User manual	Total 20 Page 14

Appendix A MODBUS-RTU Communication protocol

A.1 Communication format

Transmission of information is adopted asynchronous mode and byte as the unit. The communication data transmitted between the host and slave computer is the format of 11-digit bits, including 1 start bit(0), 8 data bits and 2 stop bits(1).

Format of information frame:

Table A.1

Start	Address code	Function code	Data field	CRC check code	End
Pause time for more than 3.5 characters	1 byte	1 byte	N bytes	2 bytes	Pause time for more than 3.5 characters

A.2 Communication information transmitting procedure

When communication command is transmitted from the host computer to the slave device ,the slave device which matches the address code sent by the host computer receives communication command. If CRC checks without any fault, then corresponding operation is carried out, after that the implement result (data) is returned to the host computer. The returned information contains address code, function code, implement date and CRC check code. No information will be returned upon erroneous CRC verification code.

A.2.1 Address code

Address code is the first byte of each communication frame, the range is 1 ~ 247. Each slave must have an exclusive address code in the bus, only the slave device which matches the address code sent by the host computer can respond returned information. When the slave device returns back information, returned data all begins with respective address code. The address code sent from the host computer indicates the slave address, and the returned address code of the slave computer indicates the slave address. The corresponding address code indicates the source of the information.

A.2.2 Function code

It's the second byte of each communication frame. It's sent by the host and tells the slave

DDSU666 Single-phase electronic type guide rail mounting electric energy meter	ZTY0.464.922
User manual	Total 20 Page 15

computer what actions should be carried out. The slave will respond, it indicates the slave have responded the host and carry out relative operations .The returned function code of the slave is the same as the function code sent by the host.

The meter supports the following two function codes:

Table A.2

Function code	Definition	Operation
03H	Read register	Read the data of one or several registers
10H	Write multi-port register	Write n 16-digit binary data into n continuous registers

A.2.3 Data field

The data field is different with different function codes. These data can be numerical values, reference addresses and so on. For different slave devices, both the address and data information are different, and the communication information table should be provided.

The host utilizes communicate command (function code 03H and 10H) to read and modify the data registers of the slave freely. But the data length which is read or write at one time should not be out of the effective range of the data register's address.

A.3 Function code

A.3.1 Function code 03H: Read register

For example: The host intends to read slave address 01H, 2 register data whose start register address is 0CH, then the host will send:

Table A.3

Host to send		Sent data
Address code		01H
Function code		03H
Start register address	High byte	00H
	Low byte	0CH
The number of registers	High byte	00H

DDSU666 Single-phase electronic type guide rail mounting electric energy meter	ZTY0.464.922
User manual	Total 20 Page 16

	Low byte	02H
CRC check code	Low byte	04H
	High byte	08H

If the data of the slave register 0CH, 0DH is 0000H, 1388H, the slave will return:

表 A.4

Slave to return		Returned information
Address code		01H
Function code		03H
The number of bytes		04H
Data of register 0CH	High byte	00H
	Low byte	00H
Data of register 0DH	High byte	13H
	Low byte	88H
CRC check code	Low byte	F7H
	High byte	65H

A.3.2 Function code 10H: Write multi-port register

For example: The host intends to keep the data 0002H、1388H、000AH into 01H slave address, 3 registers whose start register address is 00H, the host will send:

表 A.5

Host to send		Sent information
Address code		01H
Function code		10H
Start register address	high byte	00H
	low byte	00H
The number of	high byte	00H

DDSU666 Single-phase electronic type guide rail mounting electric energy meter	ZTY0.464.922
User manual	Total 20 Page 17

registers	low byte	03H
Number of written bytes		06H
Data of 00H to be written	high byte	00H
	low byte	02H
Data of 01H to be written	high byte	13H
	low byte	88H
Data of 02H to be written	high byte	00H
	low byte	0AH
CRC check code	low byte	9BH
	high byte	E9H

The slave will return:

Slave to return		Returned information
Address code		01H
Function code		10H
Start register address	high byte	00H
	low byte	00H
The number of registers	high byte	00H
	low byte	03H
CRC check code	low byte	80H
	high byte	08H

A.4 16-digit CRC check code

The host and slave can be judged by the check code to see if the received information is correct or not. The interruption by electronic noises or other factors may cause errors during information transmission. The check code can check the communication information of the host or slave is correct or not.

16-digit CRC check code is calculated by the host, it's located at the end of the transmit information frame. The slave recalculates the CRC of the received information and compares if the

DDSU666 Single-phase electronic type guide rail mounting electric energy meter	ZTY0.464.922
User manual	Total 20 Page 18

calculated CRC goes in line with the received CRC, if not, there is error. Only 8 data bits are used during CRC calculation, both the start bits and the stop bits are not involved in the calculation.

The calculation method of CRC check code is as follows:

1) Pre-arrange one 16-digit register as a hexadecimal FFFF (i.e. fully 1), the register is called CRC register;

2) Make the first 8-digit binary data (the first byte of the communication information frame) with the lower 8 digits of the 16-digit CRC register by XOR calculation, the result is placed in CRC register;

3) Shift the content of CRC register rightward by one digit (towards the lower digit) and fill in the highest digit with 0, check the shift-out digit after rightward shifting;

4) If the shift-out digit is 0: repeat step 3) (shift rightward one digit again);

If the shift-out digit is 1: make CRC register with multinomial A001 (1010 0000 0000 0001) by XOR calculation

5) Repeat step 3) and 4) until shift rightward for 8 times, then all the 8 digits are processed;

6) Repeat step 2) and 5), process the next byte of the communication information frame;

7) After calculating all the bytes of the communication information frame (exclude CRC check code) according to the above steps, the content of the CRC register to be get is: 16-digit CRC check code.

A.5 Error handling

When the meter detects other errors except the error of CRC check code, the information will be returned to the host, the highest digit of the function code is 1, i.e. the function code returned to the host from the slave is adding 128 base on the function code sent from the host. The error returned from the slave is as follows:

表 A.7

Address code	Function code (the highest digit is 1)	Error code	low byte of CRC check code	high byte of CRC check code
1 byte	1 byte	1 byte	1 byte	1 byte

DDSU666 Single-phase electronic type guide rail mounting electric energy meter	ZTY0.464.922
User manual	Total 20 Page 19

Error code is as follows:

表 A.8

01H	Illegal function code	the meter does not support the received function code
02H	Illegal register address	The received register address exceeds the register address range of the meter
03H	Illegal data value	The received data exceeds the data range of the corresponding address

DDSU666 Single-phase electronic type guide rail mounting electric energy meter	ZTY0.464.922
User manual	Total 20 Page 20

Dear Clients:

Please help me to do one thing: when the product is reaching the end of its useable life, in order to protect our environment, please do well in recovery of the products or the component materials. Please also deal with the materials which cannot be recycled.

Thank you very much for your help and support!

2016E606-33

Manufacturer: Zhejiang CHINT Instrument & Meter Co.,Ltd.

Address: Bridge Industrial Zone,325603 Wenzhou,Zhejiang,China

P.C: 325603

Tel.: 86-577-62877777

FAX: 86-577-62891577

Technical Support Hotline: 0577-62877777-9561

Service Hotline: 0577-62919999 8008577777

Counterfeit Complaints Hotline: 0577-62789987

<http://www.chint.com>

E-mail: ztyb@chint.com

Date: March, 2016

NO.: ZTY0.464.922V1