



Grid-connected PV Inverter

SUN-9K-G02P1-EU-CM2

SUN-10K-G02P1-EU-CM2

SUN-10.5K-G02P1-EU-CM2

User Manual



Contents

1. Introduction	- 1 -
1.1 Appearance Introduction	- 1 -
1.2 Labels description	- 2 -
1.3 Parts list	- 2 -
1.4 Product handling requirements	- 3 -
2. Safety warnings and instructions	- 4 -
2.1 Safety signs	- 4 -
2.2 Safety instructions	- 4 -
2.3 Notes for using	- 5 -
3. Operation Interface	- 6 -
3.1 Interface View	- 6 -
3.2 Status Indicator	- 6 -
3.3 Buttons	- 7 -
3.4 LCD Display	- 7 -
4. Product installation	- 8 -
4.1 Select installation location	- 8 -
4.2 Installations Tools	- 10 -
4.3 Inverter Installation	- 11 -
5. Electrical Connection	- 13 -
5.1 PV Module Selection	- 13 -
5.2 DC input terminal connection	- 13 -
5.3 AC input terminal connection	- 15 -
5.4 The connection of the ground line	- 16 -
5.5 Max. over current protection device	- 17 -
5.6 Monitoring solutions	- 17 -
5.7 Monitoring Platform	- 18 -
5.8 How to connect the Single-phase inverter to the router via web	- 19 -
5.9 How to connect in APP	- 23 -
5.10 USER MANUAL for SOLARMAN Smart APP	- 25 -

6. Startup and Shutdown	- 26 -
6.1 Start up the inverter	- 27 -
6.2 Inverter Shutdown	- 27 -
6.3 Anti-PID Function(optional)	- 27 -
6.4 DRM wiring diagram(optional)	- 28 -
6.5 LCD night power supply(optional)	- 28 -
7. Zero-export function via energy meter	- 29 -
7.1 Use of zero-export function	- 38 -
7.2 Sensor Clamp(optional)	- 38 -
7.3 Use of limiter function	- 40 -
7.4 Notes while using limiter function	- 41 -
7.5 How to browse the load power of your PV grid-tieplant on monitoring platform?	- 41 -
8. General Operation	- 43 -
8.1 The initial interface	- 44 -
8.2 Submenus in the Main Menu	- 45 -
8.3 System param setting	- 47 -
8.4 Running param setting	- 48 -
8.5 Protect Param setting	- 52 -
8.6 Comm. param setting	- 54 -
9. Repair and Maintenance	- 55 -
10. Error information and processing	- 55 -
10.1 Error code	- 55 -
11. Specification	- 59 -
12. EU Declaration of Conformity	- 60 -

About This Manual

The manual mainly describes the product information, guidelines for installation, operation and maintenance. The manual cannot include complete information about the photovoltaic (PV) system.

How to Use This Manual

Read the manual and other related documents before performing any operation on the inverter. Documents must be stored carefully and be available at all times. **Contents may be periodically updated or revised due to product development. The information in this manual is subject to change without notice.**The latest manual can be acquired via service@deye.com.cn

Photovoltaic Grid-connected System

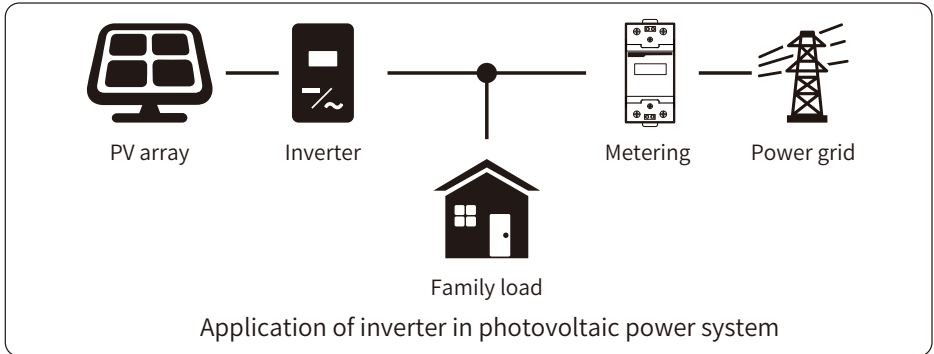

1. Introduction

1.1 Appearance Introduction

Single Phase String Power Inverter can convert solar panel DC power into AC power which can directly input to the grid. Its appearance is shown below. These models contain SUN-9K-G02P1-EU-CM2, SUN-10K-G02P1-EU-CM2, SUN-10.5K-G02P1-EU-CM2.

The following is collectively referred to as “inverter” .

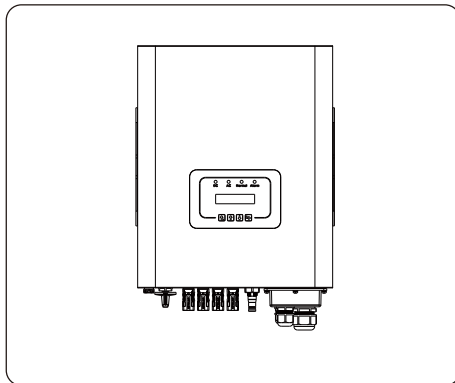

Pic 1.1 Front view

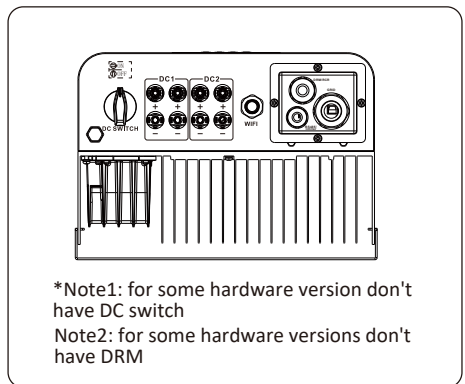





*Note1: for some hardware version don't have DC switch

Note2: for some hardware versions don't have DRM





Pic 1.2 Bottom view

1.2 Labels description

Label	Description
	Caution, risk of electric shock symbol indicates important safety instructions, which if not correctly followed, could result in electric shock.
	The DC input terminals of the inverter must not be grounded.
	CE mark of conformity
	Please read the instructions carefully before use.
	Symbol for the marking of electrical and electronics devices according to Directive 2002/96/EC. Indicates that the device, accessories and the packaging must not be disposed as unsorted municipal waste and must be collected separately at the end of the usage. Please follow Local Ordinances or Regulations for disposal or contact an authorized representative of the manufacturer for information concerning the decommissioning of equipment.

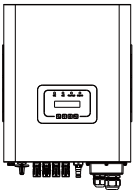
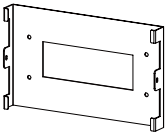
1.3 Parts list

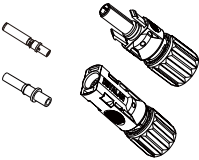
Please check the following table, to see whether all the parts are included in the package:

		
Grid-tied PV String Inverter x1	Wall mounting bracket x1	Stainless steel screws M4×12 x3
		
DC+/DC- Plug connectors including metal terminal xN	Stainless steel anti-collision bolt M6×60 x4	User manual x1

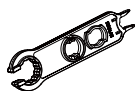

Solar Photovoltaic
Connector Special
Spanner x1



Meter(optional) x1

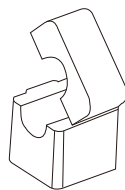

Sensor Clamp(optional) x1



DRM connector x 1(optional)

1.4 Product handling requirements

Lift the inverter out of the packaging box and transport it to the designated installation location.

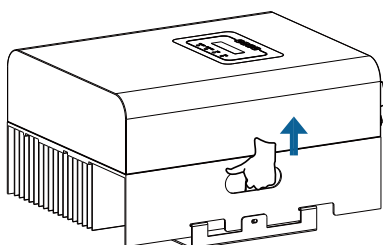

transport



CAUTION:

Improper handling may cause personal injury!

- Arrange an appropriate number of personnel to carry the inverter according to its weight, and installation personnel should wear protective equipment such as anti-impact shoes and gloves.
- Placing the inverter directly on a hard ground may cause damage to its metal enclosure. Protective materials such as sponge pad or foam cushion should be placed underneath the inverter.
- Move the inverter by one or two people or by using a proper transport tool.
- Move the inverter by holding the handles on it. Do not move the inverter by holding the terminals.

2. Safety warnings and instructions

Improper use may result in potential electric shock hazards or burns. This manual contains important instructions that should be followed during installation and maintenance. Please read these instructions carefully before use and keep them for future reference.

2.1 Safety signs

Safety symbols used in this manual, which highlight potential safety risks and important safety information, are listed as follows:



Warning:

Warning symbol indicates important safety instructions, which if not correctly followed, could result in serious injury or death.



Shock Hazard:

Caution, risk of electric shock symbol indicates important safety instructions, which if not correctly followed, could result in electric shock.



Safety Hint:

Note symbol indicates important safety instructions, which if not correctly followed, could result in some damage or the destruction of the inverter.



High Temperature Hazard:

Caution, hot surface symbol indicates safety instructions, which if not correctly followed, could result in burns.

2.2 Safety instructions



Warning:

Electrical installation of the inverter must conform to the safety operation rules of the country or local area.

**Warning:**

Inverter adopts non-isolated topology structure, hence must insure DC input and AC output are electrical isolated before operating the inverter.

**Shock Hazard:**

Prohibit disassembling inverter case, there existing shock hazard, which may cause serious injury or death, please ask qualified person to repair.

**Shock Hazard:**

When PV module is exposed to sunlight, the output will generate DC voltage. Prohibit touching to avoid shock hazard.

**Shock Hazard:**

While disconnect the input and output of the inverter for maintenance, please waits for at least 5 mins until the inverter discharge the remnant electricity.

**High Temperature Hazard:**

Local temperature of inverter may exceed 80°C while under operating. Please do not touch the inverter case.

2.3 Notes for using

The single phase string power inverter is designed and tested under related safety regulations. It can ensure the personal safety of the user. But as a electric device, it may cause shock or injury by incorrect operation. Please operate the unit under below requirements:

1. Inverter should be installed and maintained by qualified person under local standard regulations.
 2. Must disconnect the AC side first, then disconnect DC side while doing installation and maintenance, after that, please wait at least 5 mins to avoid getting shocked.
 3. Local temperature of the inverter may exceed 80 °C while under operating. Do not touch to avoid getting injured.
 4. All electrical installation must be in accord with local electrical standards, and after obtaining the permission of the local power supply department, the professionals can connect the inverter to the grid.
 5. Please take appropriate anti-static measure.
 6. Please install where children can not touch.
 7. The steps to start the inverter: 1) switch on the AC side circuit breaker, 2) Switch on the DC side circuit breaker of the PV panel. 3) Turn on the DC switch of the inverter.
- The steps to stop the inverter: 1) switch off the AC side circuit breaker, 2) switch off the DC side circuit breaker of the PV panel. 3) Turn off the DC switch of the inverter.

8. Don't insert or remove AC and DC terminals when the inverter is in normal operation.

9. The DC input voltage of the inverter must not exceed the maximum value of the model.

3. Operation Interface

3.1 Interface View

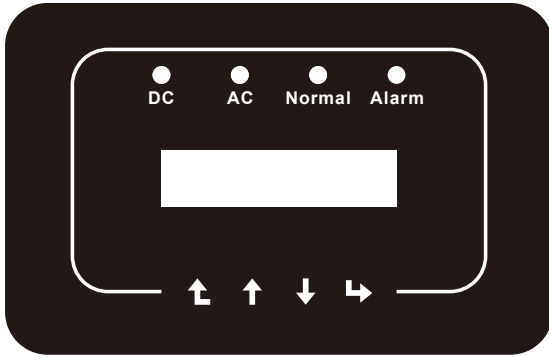

Pic 3.1 Front panel display

3.2 Status Indicator

There are four LED status indicator lights in the front panel of the inverter. Please see table 3.1 for details.

Indicator	status	Explanation
● DC	on	Inverter detects DC input
	off	Low DC input voltage
● AC	on	Grid Connected
	off	Grid Unavailable
● NORMAL	on	Under normal operating
	off	Stop operating
● ALARM	on	Detected faults or report faults
	off	Under normal operating

Table 3.1 Status indicator lights

3.3 Buttons

There are four keys in the front panel of the Inverter(from left to right): Esc, Up, Down and Enter keys. The keypad is used for:

- Scrolling through the displayed options (the Up and Down keys);
- Access to modify the adjustable settings (the Esc and Enter keys).



3.4 LCD Display

The two-line Liquid Crystal Display (LCD) is located on the front panel of the Inverter, which shows the following information:

- Inverter operation status and data;
- Service messages for operator;
- Alarm messages and fault indications.

4. Product installation

4.1 Select installation location

To select a location for the inverter, the following criteria should be considered:

WARNING: Risk of fire

- Do not install the inverter in areas containing highly flammable materials or gases.
- Do not install the inverter in potentially explosive atmospheres.
- Do not install in small closed spaces where air can not circulate freely. To avoid overheating, always make sure the flow of air around the inverter is not blocked.
- Exposure to direct sunlight will increase the operational temperature of the inverter and may cause output power limiting. It is recommended that inverter installed to avoid direct sunlight or raining.
- To avoid overheating ambient air temperature must be considered when choosing the inverter installation location. It is recommended that using a sun shade minimizing direct sunlight when the ambient air temperature around the unit exceeds 104°F/40°C.



- Install on a wall or strong structure capable of bearing the weight.
- Install vertically with a maximum incline of +15°. If the mounted inverter is tilted to an angle greater than the maximum noted, heat dissipation can be inhibited, and may result in less than expected output power.
- If install more than one inverter, must leave at least 500mm gap between each inverter. And two adjacent inverters are also separated by at least 500 mm. And must install the inverter at the place where children cannot touch. Please see picture 4.3.
- Consider whether the installation environment is helpful to see the inverter LCD display and indicator status clearly.
- Must offer a ventilate environment if inverter installed in the airtight house.



Safety Hint:

Do not place or store any items next to the inverter.

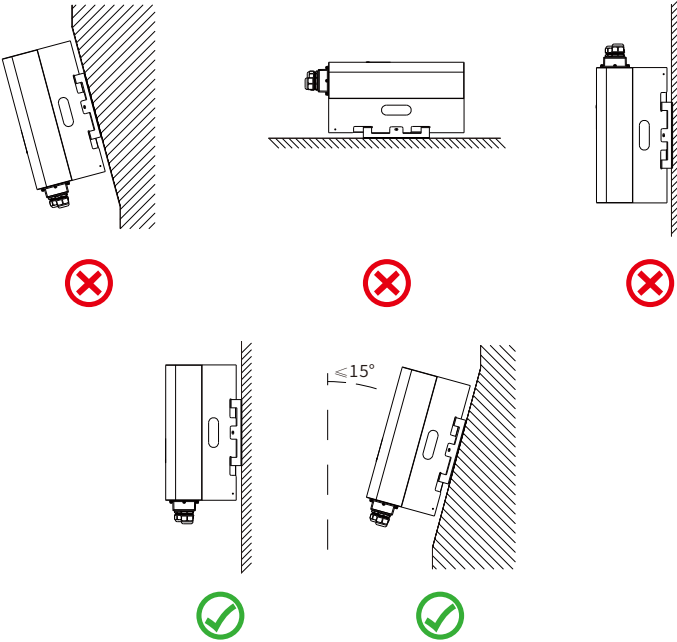

Pic 4.2 Installation Angle

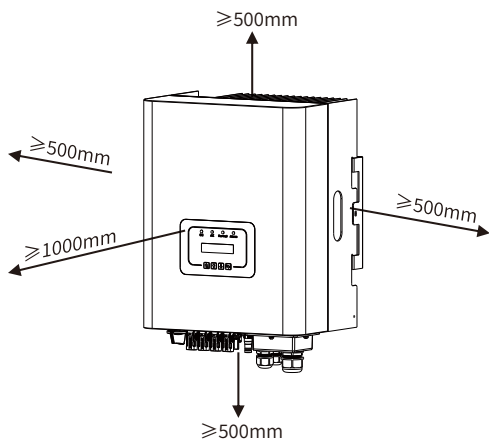

Pic 4.3 Installation Gap

4.2 Installations Tools

Installation tools can refer to the following recommended ones. Also, use other auxiliary tools on site.

table 4-1 Tool specification

Protective goggles	Anti-dust mask	Earplugs	Work gloves	Work shoes	Utility Knife	Slotted screwdriver
Cross screwdriver	Percussion drill	Pliers	Marker	Level	Rubber hammer	socket wrenches set
Anti-static wrist strap	Wire cutter	Wire stripper	Hydraulic pliers	Heat gun	Crimping tool 4-6mm ²	Solar connector wrench
Multimeter ≥ 1100 Vdc	RJ45 crimping plier	Cleaner				

4.3 Inverter Installation

The inverter is designed according to the wall mounted type installation, please use the wall mounted (the brick wall of the expansion bolt) when installing.

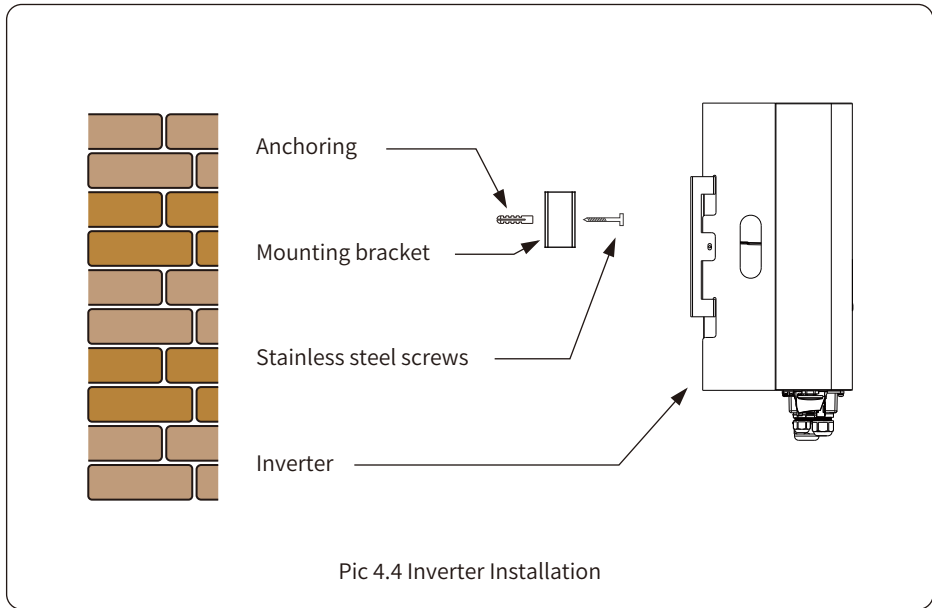

Procedure shows below:

1. Locate on the appropriate wall according to the bolt position on the mounting bracket, then mark the hole. On the brick wall, the installation must be suitable for the expansion bolt installation.

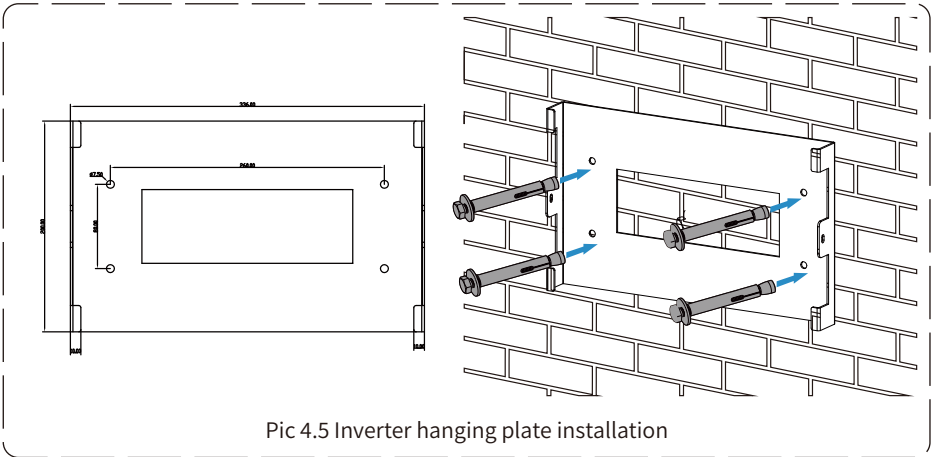

2. Ensure that the position of the installation holes on the wall is in accordance with the mounting plate, and the mounting rack is vertically placed.
3. Hang the inverter to the top of the mounting rack and then use the M4 screw in the accessory to lock inverter heat sink to the hanging plate, to ensure that the inverter will not move.

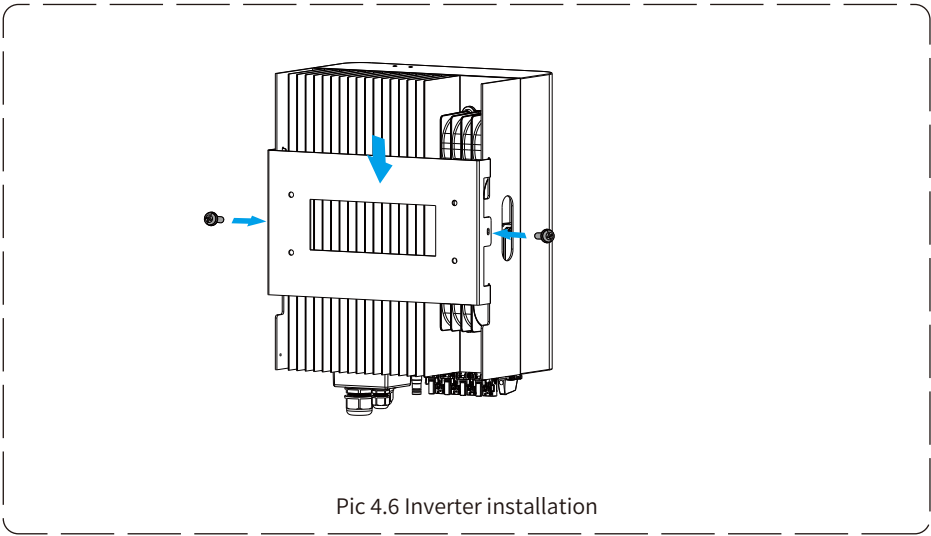

5. Electrical Connection

5.1 PV Module Selection:

When selecting proper PV modules, please be sure to consider below parameters:

- 1) Open circuit Voltage (Voc) of PV modules not exceeds max. PV array open circuit voltage of inverter.
- 2) Open circuit Voltage (Voc) of PV modules should be higher than min. start voltage.
- 3) The PV modules used to connected to this inverter shall be Class A rating certified according to IEC 61730.

Inverter Model	SUN-9K-G02P1 -EU-CM2	SUN-10K-G02P1 -EU-CM2	SUN-10.5K-G02P1 -EU-CM2
Start-up DC Input Voltage(V)	80V		
Max.DC Input Voltage(V)	550V		
PV Array MPPT Voltage Range	70V-500V		
No. of MPP Trackers	2		
No. of Strings MPP Tracker	2+2		

5.2 DC input terminal connection

- 1. Switch the Grid Supply Main Switch(AC)OFF.
- 2. Switch the DC Isolator OFF.
- 3. Assemble PV input connector to the inverter.



Warning:

When using PV modules, please ensure the PV+ & PV- of solar panel is not connected to the system ground bar.



Safety Hint:

Before connection, please make sure the polarity of the output voltage of PV array matches the “DC+” and “DC-” symbols.



Warning:

Before connecting inverter, please make sure the PV array open circuit voltage is within the 550V of the inverter.



Pic 5.1 DC+ male connector

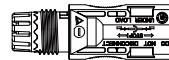

Pic 5.2 DC- female connector



Safety Hint:

Please use approved DC cable for PV system.

Cable type	Cross section (mm ²)	
	Range	Recommended value
Industry generic PV cable (model: PV1-F)	2.5-4.0 (12-10AWG)	2.5(12AWG)

Table 5.1 DC Cable Specifications

The steps to assemble the DC connectors are listed as follows:

a) Strip off the DC wire about 7mm, disassemble the connector cap nut (see picture 5.3).

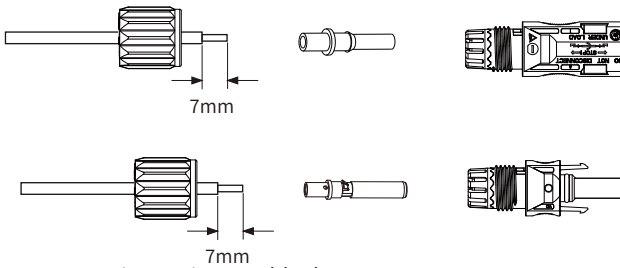

Pic 5.3 Disassemble the connector cap nut

b) Crimping metal terminals with crimping pliers as shown in picture 5.4.

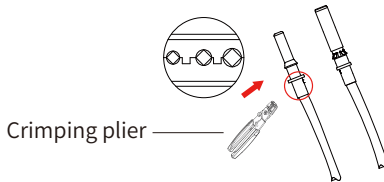

Pic 5.4 Crimp the contact pin to the wire

c) Insert the contact pin to the top part of the connector and screw up the cap nut to the top part of the connector. (as shown in picture 5.5).

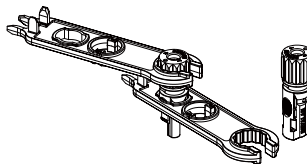

Pic 5.5 connector with cap nut screwed on

d) Finally insert the DC connector into the positive and negative input of the inverter, shown as picture 5.6.

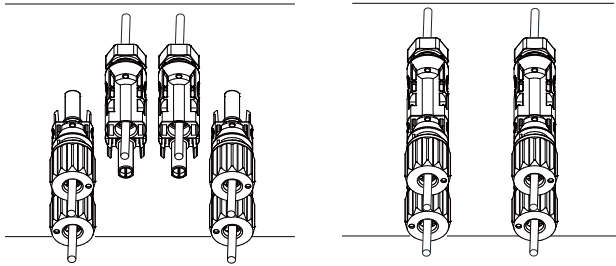

Pic 5.6 DC input connection



Warning:

Sunlight shines on the panel will generate voltage, high voltage in series may cause danger to life. Therefore, before connecting the DC input line, the solar panel needs to be blocked by the opaque material and the DC switch should be 'OFF', otherwise, the high voltage of the inverter may lead to life-threatening conditions.



Warning:

Please use its own DC power connector from the inverter accessories. Do not interconnect the connectors of different manufacturers. Max. DC input current should be 20A. if exceeds, it may damage the inverter and it is not covered by Deye warranty.

5.3 AC input terminal connection

Do not close the DC switch immediately after the DC terminal has been connected. Connect the AC wires to the AC terminals on the AC side of the inverter. Flexible wires are recommended for easy installation, as shown in Table 5.2.



Warning:

Prohibit using a single circuit breaker for multiple inverters, prohibit the connection of load between inverter circuit breakers.

Model	Cable CSA	AWG	Breaker	Max cable length
SUN-9K-G02P1-EU-CM2	10mm ²	6	60A/400V	Outside cable (L+N+PE)20m
SUN-10K-G02P1-EU-CM2	10mm ²	6	60A/400V	
SUN-10.5K-G02P1-EU-CM2	10mm ²	6	60A/400V	

Table 5.2 Cable information

5.4 The connection of the ground line

Good grounding is good for resisting surge voltage shock and improving EMI performance. Therefore, before connecting AC, DC and communication cables, you need to ground the cable firstly. For a single system, just ground the PE cable. For multiple machine systems, all PE cables of the inverter need to be connected to the same grounding copper platoon to ensure the equipotential connection. The installation of the shell ground wire is shown as picture 5.11. The external protective earthing conductor is made of the same metal as the phase conductor.

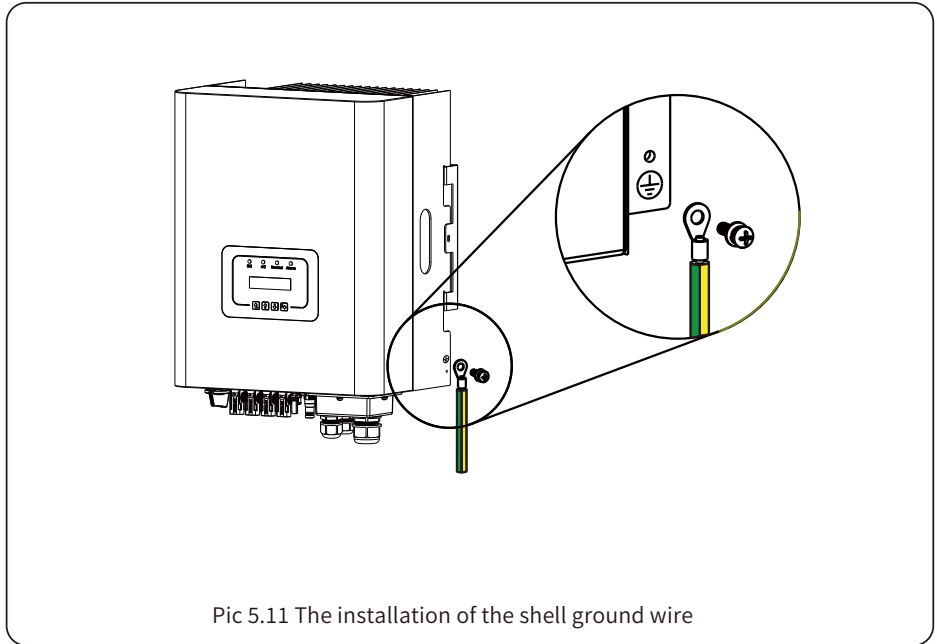

Model	Wire Size	Cable(mm ²)	Torque value(max)
SUN-9/10/10.5-G02P1-EU-CM2	6AWG	10mm ²	8.5Nm



Warning:

Inverter has built-in leakage current detection circuit, The type A RCD can be connected to the inverter for protection according to the local laws and regulations. If an external leakage current protection device is connected, its operating current must be equal to 300 mA or higher, otherwise inverter may not work properly.

5.5 Max. over current protection device

In order to protect the inverter AC connection, it is recommended to install a circuit breaker to prevent overcurrent. See table 5.3 below.

Inverter	Rated output voltage(V)	Rated output current(A)	Current for protection device(A)
SUN-9K-G02P1-EU-CM2	220/230	41/39.2A	60
SUN-10K-G02P1-EU-CM2	220/230	45.5/43.5A	60
SUN-10.5K-G02P1-EU-CM2	220/230	47.8/45.7A	60

Table 5.3 Recommended current protector specifications

5.6 Monitoring solutions

The inverter is equipped with a built-in data logger module that supports 4G or Wi-Fi communication (optional), so it has remote monitoring function.

Specification of WiFi module:

Frequency range: 2.412GHz-2.472GHz

Module maximum transmitting power: 802.11b: $+17 \pm 1.5$ dBm (@11Mbps)

802.11g: $+15 \pm 1.5$ dBm (@54Mbps) 802.11n: $+14 \pm 1.5$ dBm (@HT20, MCS7)

Antenna: External Antenna

Antenna Gain: 2dBi

Specification of 4G module:

Frequency range: FDD-LTE: B1, B3, B5, B8 TDD-LTE: B34, B38, B39, B40, B41

Module maximum transmitting power: LTE: $+23$ dBm ± 2 dBm

Antenna: External Antenna

Antenna Gain: Low Band ≥ -8.8 dBi High Band ≥ -19.3 dBi

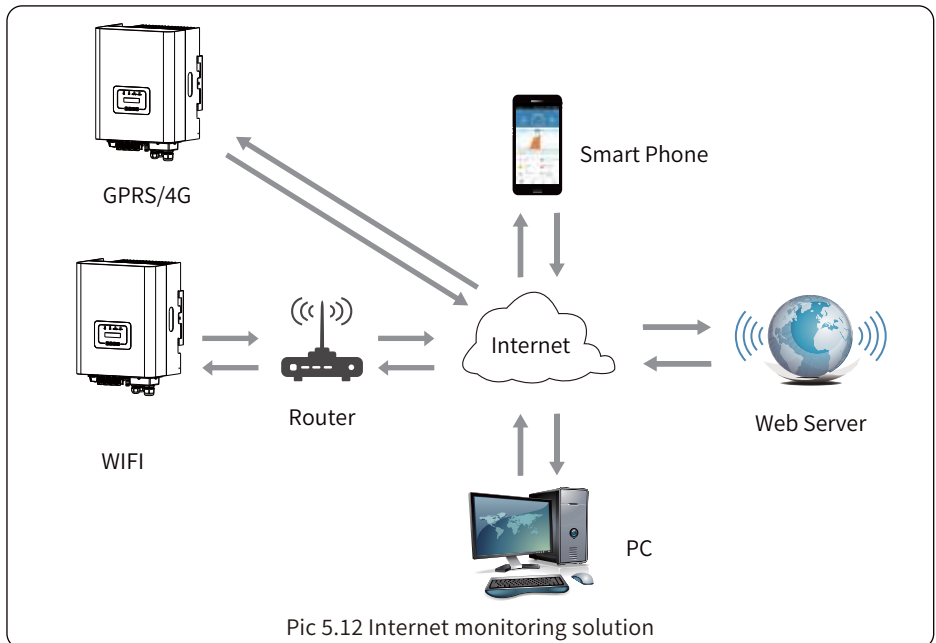

Pic 5.12 Internet monitoring solution

5.7 Monitoring Platform

This series Single-phase inverter has built-in WIFI modular which is able to connect router directly. For WIFI configuration, please check the manual of “Built-in WIFI modular Single-phase inverter WIFI configuration Manual”.

Web monitoring address: <https://pro.solarmanpv.com>; (for Solarman distributor account)
<https://home.solarmanpv.com> (for Solarman end user account)

For mobile phone monitoring system, scan the QR code to download the APP.

Also you can find it by searching “solarman business” in App store or Google Play store, and this App is for distributor/installer.

Find it by searching “solarman smart” in App store or Google Play store and choose “solarman smart”, this app is for plant owner.



SOLARMAN Smart
for end user



SOLARMAN Business
for distributor/installer

5.8 How to connect the Single-phase inverter to the router via web



WiFi configuration
manual

1. Turn on the wireless network of your PC or smartphone.
2. The default password of the AP network is 12345678 if there's no nameplate that includes PWD:XXXXXXXX on the inverter body. If there's nameplate that includes PWD:XXXXXXXX on the inverter body then the AP network password is the "XXXXX XXX": for example, the default password of AP network is "5c4db4d8" of the inverter SN:2302202012.

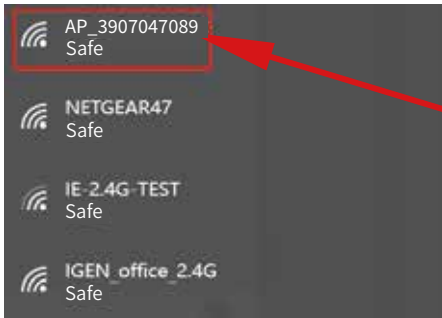

Single-phase inverter SN: 2302202012 Built-in datalogger :3907047089

Also, the default password can be changed. If forgetting the modified password, please contact service@deye.com.cn for help.

3. Open a browser and enter **10.10.100.254**. Both username and password are "admin". (Recommended browser: IE 8+, Chrome 15+, Firefox 10+).

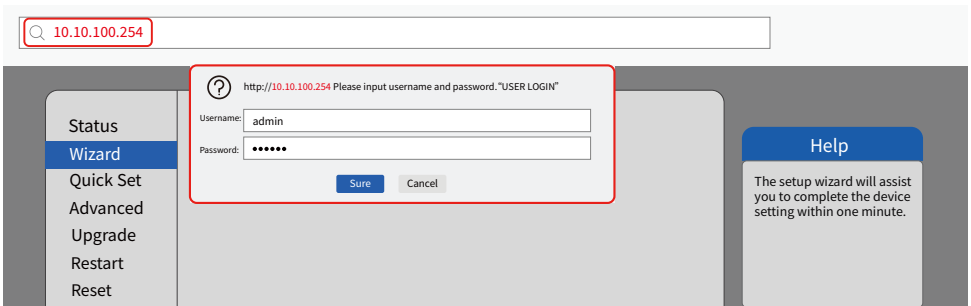

4. Browser jumps to "Status" page, the basic information is listed there.

Status			Help
Wizard	- Inverter information		<p>The device can be used as a wireless access point(AP mode) to facilitate users to configure the device, or it can also be used as a wireless information terminal (STA mode) to connect the remote server via wireless router.</p> <p>Status of remote server</p> <ul style="list-style-type: none"> • Not connected: Connection to server failed last time. If under such status, please check the issues as follows: (1)check the device information to see whether IP address is obtained or not; (2)check if the router is connected to internet or not; (3)check if a firewall is set on the router or not; • Connected: connection to server successful last time; • Unknown: No connection to server.Please check again in 5 minutes.
Quick Set	Inverter serial number: --- Firmware version(main): --- Firmware version(slave): --- Inverter model: --- Rated power: --- W Current power: --- W Yield today: --- kWh Current power: --- kWh Alerts: --- Last updated: ---		
Advanced	- Device information		
Upgrade	Device serial number: 3907047089 Firmware version: LSW3_14_FFFF_1.0.23 Wireless AP mode: Enable SSID: AP_1704013242 IP address: 10.10.100.254 MAC address: 8C:D8:B3:71:8D:B0 Wireless STA mode: Disable Router SSID: _____ Signal Quality: _____ IP address: _____ MAC address: _____		
Restart	- Remote server information		
Reset	Remote server A: Not connected Remote server B: Not connected		

5. Turn to "Wizard" page, click "Refresh" to search the wireless network. Select the target network and click "Next".

Status			Help																																																												
Wizard	Please select your current wireless network: <table border="1"> <tr> <td><input checked="" type="radio"/></td> <td>IE-2.4G-TEST</td> <td>54:A7:3:70:99:13</td> <td>82</td> <td>1</td> </tr> <tr> <td><input type="radio"/></td> <td>AP_1753738492</td> <td>0:BE:D5:20:B8:2C</td> <td>80</td> <td>1</td> </tr> <tr> <td><input type="radio"/></td> <td>IGEN_office_2.4G</td> <td>30:EA:E7:36:B:36</td> <td>78</td> <td>2</td> </tr> <tr> <td><input type="radio"/></td> <td>IGENTEST</td> <td>0:BE:D5:20:B8:2C</td> <td>76</td> <td>1</td> </tr> <tr> <td><input type="radio"/></td> <td>IGEN_office_2.4G</td> <td>E8:65:D4:F2:15:B8</td> <td>74</td> <td>6</td> </tr> <tr> <td><input type="radio"/></td> <td>IGEN_office_2.4G</td> <td>90:5D:7C:97:95:29</td> <td>74</td> <td>1</td> </tr> <tr> <td><input type="radio"/></td> <td>IGEN_office_2.4G</td> <td>90:5D:7C:97:95:27</td> <td>72</td> <td>1</td> </tr> <tr> <td><input type="radio"/></td> <td>IGEN_office_2.4G</td> <td>90:5D:7C:97:C9:E5</td> <td>72</td> <td>1</td> </tr> <tr> <td><input type="radio"/></td> <td>AP_1719065936</td> <td>30:EA:E7:36:CF:B2</td> <td>70</td> <td>1</td> </tr> <tr> <td><input type="radio"/></td> <td>IGEN_office_2.4G</td> <td>90:5D:7C:97:C9:E3</td> <td>70</td> <td>1</td> </tr> <tr> <td><input type="radio"/></td> <td>TESR+™ ™; ;</td> <td>4A:EC:9E:C3:3E</td> <td>70</td> <td>11</td> </tr> <tr> <td><input type="radio"/></td> <td>IGEN_office_2.4G</td> <td>0:BE:D5:20:B7:EE</td> <td>66</td> <td>11</td> </tr> </table> <p>* Note: When RSSI of the selected WiFi network is lower than 15%, the connection may be unstable, please select other available network or shorten the distance between the device and router.</p> <p style="text-align: right;">Refresh</p>		<input checked="" type="radio"/>	IE-2.4G-TEST	54:A7:3:70:99:13	82	1	<input type="radio"/>	AP_1753738492	0:BE:D5:20:B8:2C	80	1	<input type="radio"/>	IGEN_office_2.4G	30:EA:E7:36:B:36	78	2	<input type="radio"/>	IGENTEST	0:BE:D5:20:B8:2C	76	1	<input type="radio"/>	IGEN_office_2.4G	E8:65:D4:F2:15:B8	74	6	<input type="radio"/>	IGEN_office_2.4G	90:5D:7C:97:95:29	74	1	<input type="radio"/>	IGEN_office_2.4G	90:5D:7C:97:95:27	72	1	<input type="radio"/>	IGEN_office_2.4G	90:5D:7C:97:C9:E5	72	1	<input type="radio"/>	AP_1719065936	30:EA:E7:36:CF:B2	70	1	<input type="radio"/>	IGEN_office_2.4G	90:5D:7C:97:C9:E3	70	1	<input type="radio"/>	TESR+™ ™; ;	4A:EC:9E:C3:3E	70	11	<input type="radio"/>	IGEN_office_2.4G	0:BE:D5:20:B7:EE	66	11	<p>The setup wizard will assist you to complete the device setting within one minute.</p>
<input checked="" type="radio"/>	IE-2.4G-TEST	54:A7:3:70:99:13	82	1																																																											
<input type="radio"/>	AP_1753738492	0:BE:D5:20:B8:2C	80	1																																																											
<input type="radio"/>	IGEN_office_2.4G	30:EA:E7:36:B:36	78	2																																																											
<input type="radio"/>	IGENTEST	0:BE:D5:20:B8:2C	76	1																																																											
<input type="radio"/>	IGEN_office_2.4G	E8:65:D4:F2:15:B8	74	6																																																											
<input type="radio"/>	IGEN_office_2.4G	90:5D:7C:97:95:29	74	1																																																											
<input type="radio"/>	IGEN_office_2.4G	90:5D:7C:97:95:27	72	1																																																											
<input type="radio"/>	IGEN_office_2.4G	90:5D:7C:97:C9:E5	72	1																																																											
<input type="radio"/>	AP_1719065936	30:EA:E7:36:CF:B2	70	1																																																											
<input type="radio"/>	IGEN_office_2.4G	90:5D:7C:97:C9:E3	70	1																																																											
<input type="radio"/>	TESR+™ ™; ;	4A:EC:9E:C3:3E	70	11																																																											
<input type="radio"/>	IGEN_office_2.4G	0:BE:D5:20:B7:EE	66	11																																																											
Quick Set	Add wireless network manually: Network name (SSID) (Note:case sensitive): IE-2.4G-TEST Encryption method: WPA2PSK Encryption algorithm: AES <p style="text-align: right;">Next</p>																																																														
Advanced	<p style="text-align: center;">1 2 3 4</p>																																																														

6. Enter the password and click Next.

Status

Wizard

Quick Set

Advanced

Upgrade

Restart

Reset

Please fill in the following information:

Password(8-64 bytes)
(Note: case sensitive)

••••••••

Show Password

Obtain an IP address automatically **Enable**

IP address

Subnet mask

Gateway address

DNS server address

Back **Next**

1 2 3 4

Help

Most systems support the function of DHCP to obtain IP address automatically. Please select disable and add it manually if your router does not support such function.

7. Users can select any options below to enhance the security and click Next.

Status

Wizard

Quick Set

Advanced

Upgrade

Restart

Reset

Enhance Security

You can enhance your system security by choosing the following methods

Hide AP

Change the encryption mode for AP

Change the user name and password for Web server

Back **Next**

1 2 3 4

Help

Change the encryption mode for AP
If you set password for the AP network, you will need to enter the password to connect to AP.

Change the user name and password for Web server
If you change the username and password for the web server, you will need to enter the new username and password to get access to the setting page.

8. If the setup is successful, the following page will pop up and click OK to reboot the Single-phase inverter.

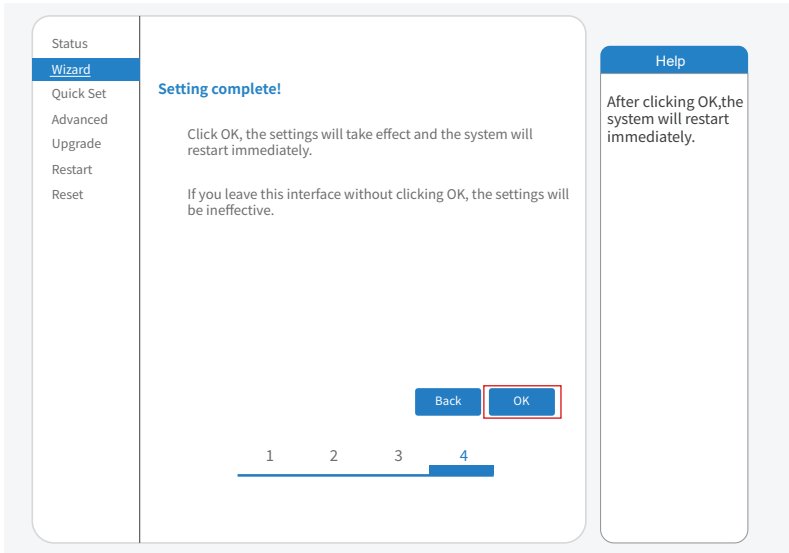

9. Connect to logger AP network again, then log in to 10.10.100.254 by Browser, and check the system info of "Status" page. After the network setting is done, the remote server A or B should be "connected".

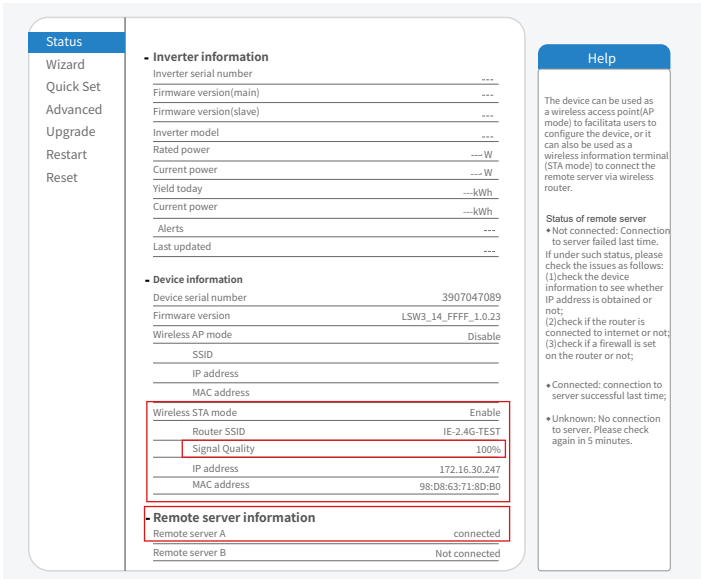

10. When it shows "connected" which means this Single-phase inverter has connected solarman platform successfully. Generally speaking, it will be online after 10-15min after configuration successfully at the first time.

5.9 How to connect in APP

1. Registration

Open the app of SOLARMAN Smart and register an account.
Click "Register" and create your account here.

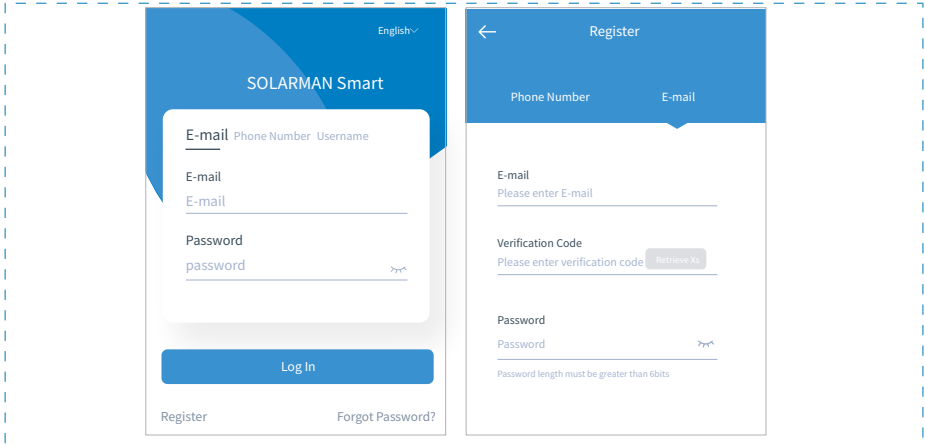

2. Create a Plant

Click "Add Now" to create your plant.
Please fill in plant basic info and other info here.

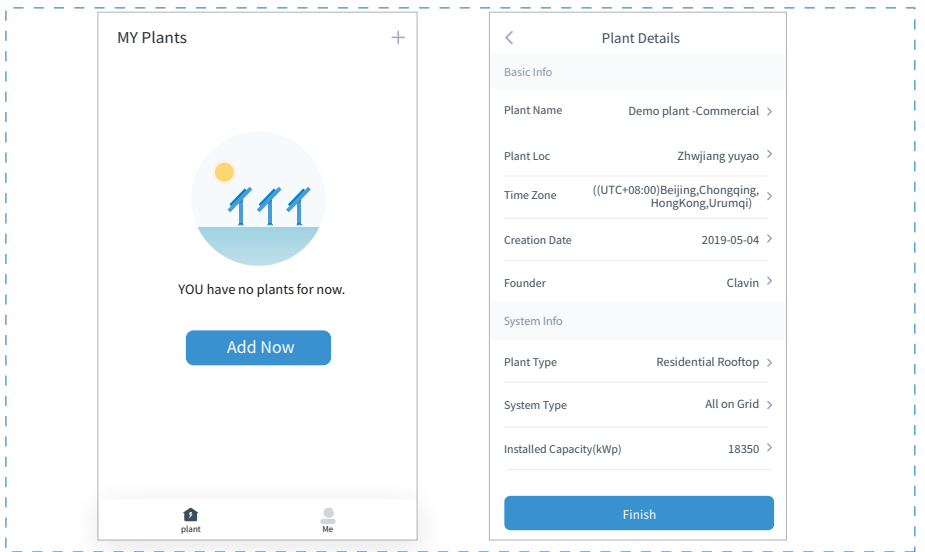

3. Add a Logger

Optional 1: Enter the logger SN manually.

Optional 2: Click the icon in the right and scan the QR code to enter logger SN.

You can find logger SN on the carton packaging or on the logger body.

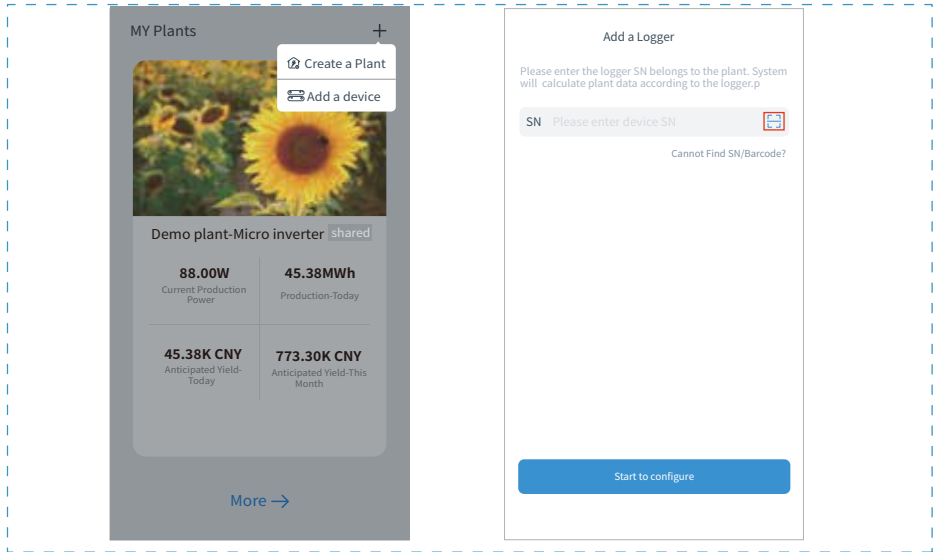

4. Network Configuration

After the logger is added, please configure the network to ensure normal operation.

Go to "Plant Details"- "Device List", find the target SN and click " Device Networking".

If showing "online" which means the datalogger of the inverter connects the solarman platform successfully. Then you will be able to check the plant info on the platform.

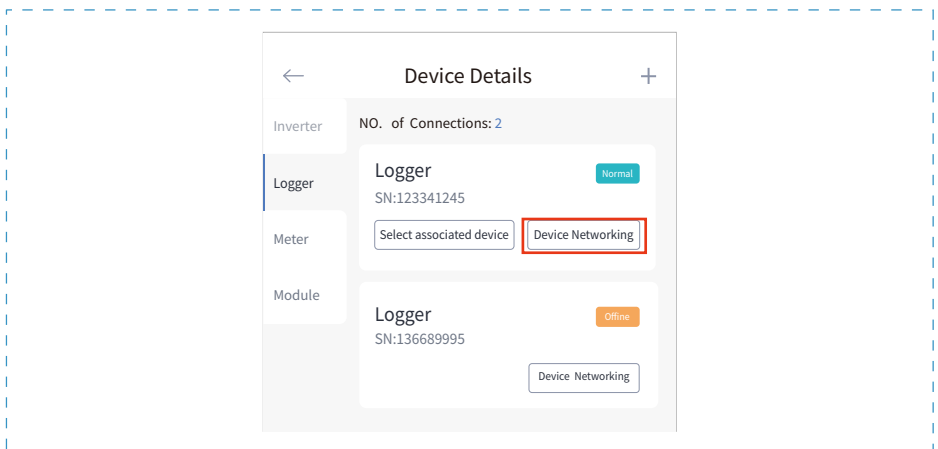

5.10 USER MANUAL for SOLARMAN Smart APP

1.Add a Logger

Method 1: Enter logger SN manually.

Method 2: Click the icon in the right and scan to enter logger SN

You can find logger SN in the external packaging or on the logger body.

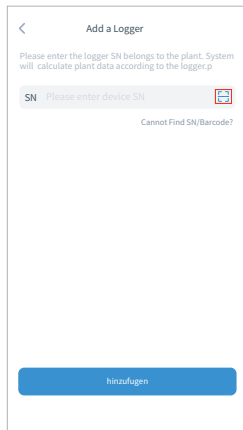
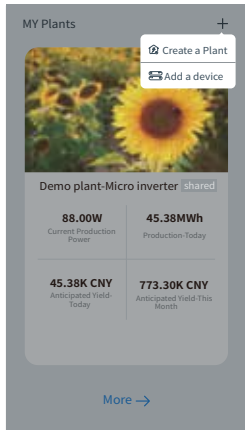

2.Network Configuration

Step 1: Click “Go to Configure” to set the network. (Please make sure Bluetooth and WiFi are ON.)

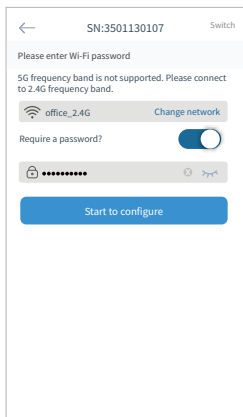
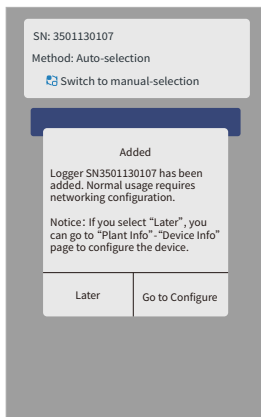

Step 2: Please wait for a few minute. Then click "Done" and view plant data.

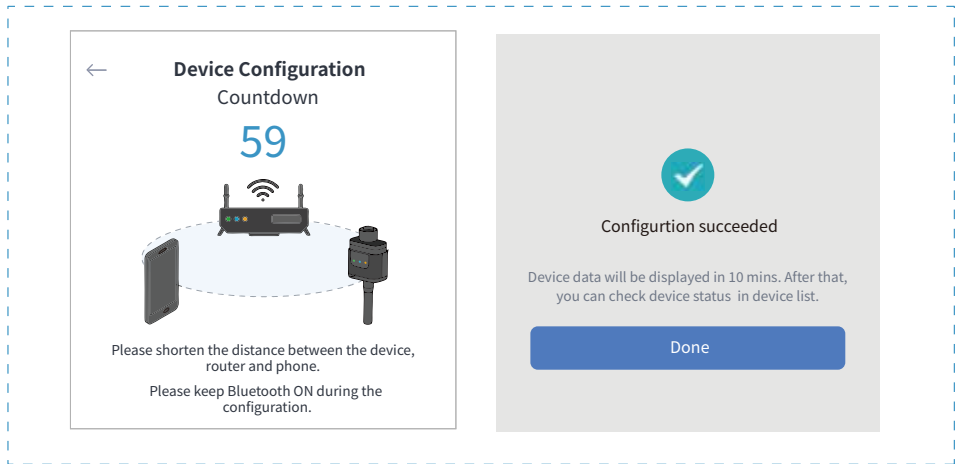

NOTE

5G WiFi is not supported .

REMARQUE

Le Wi-Fi 5G n' est pas pris en charge.

6. Startup and Shutdown

Before starting the inverter, make sure that the inverter can meet the following conditions, otherwise it may result in fire or damage to the inverter. In this case, we do not undertake any responsibility. At the same time, to optimize the system configuration, it is recommended that the two inputs be connected to the same number of photovoltaic modules.

- a). The maximum open circuit voltage of each set of photovoltaic modules shall not exceed 550Vdc under any conditions.
- b). Each input of the inverter better use the same type of photovoltaic module in series.
- c). Total output power of PV shall not exceed the maximum input power of inverter, each photovoltaic modules shall not exceed the rated power of each channel.

6.1 Start up the inverter

When starting up the Single Phase String Power Inverter , should follow steps below:

1. Starting switch on the AC breaker.
2. Turn on the DC switch of the PV module, and if the panel provides sufficient starting voltage and power, the inverter will start.
3. The inverter will first check the internal parameters and the grid parameters, while the liquid crystal will show that the inverter is self-checking.
4. If the parameter is within acceptable range, the inverter will generate energy.
NORMAL indicator light is on.

6.2 Inverter Shutdown

Must follow below steps while shutting down the inverter:

1. Switch off the AC breaker.
2. Wait for 30 seconds, turn off the DC switch (if any). The inverter will close the LCD and all indicators within two minutes.

6.3 Anti-PID Function(optional)

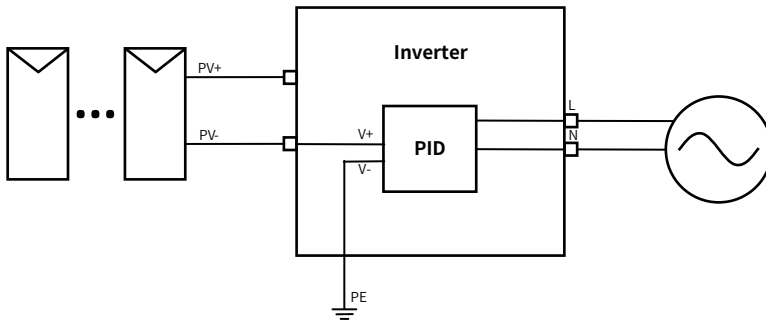

The Anti-PID module repairs the PID effect of the PV module at night. The PID module always runs when connected to AC.

If maintenance is required and turn off the AC switch can disable the Anti-PID function.



WARNING:

The PID functionality is automatic. When the DC bus voltage is below 50VDC, the PID module will create 450VDC between the PV and ground. No control and equipment are required.



WARNING:

If you need to maintain the inverter, Please turn off the AC switch first, then turn off the DC switch, and wait 5 minutes before you do other operations.

6.4 DRM(RCR) wiring diagram(optional)

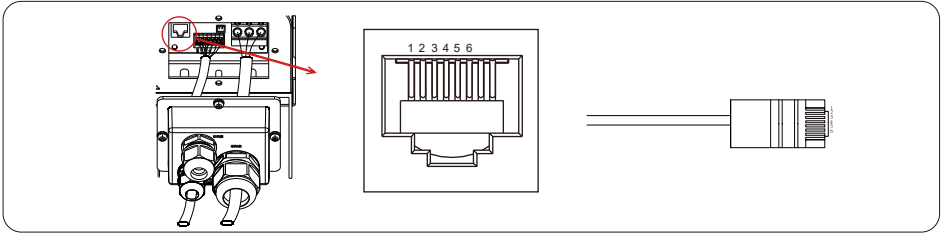

"AU"/"NZ": Demand Response Modes(DRMs)

In Australia and New Zealand, the inverter supports the demand response modes as specified in the standard AS/NZS 4777.2 as shown in Pic 6.1.

"DE": Ripple Control Receiver (RCR)

In Germany, the grid company uses the Ripple Control Receiver to convert the grid dispatching signal and send it as a dry contact signal. The inverter can control power output according to the local preset instructions as shown in Pic 6.2.

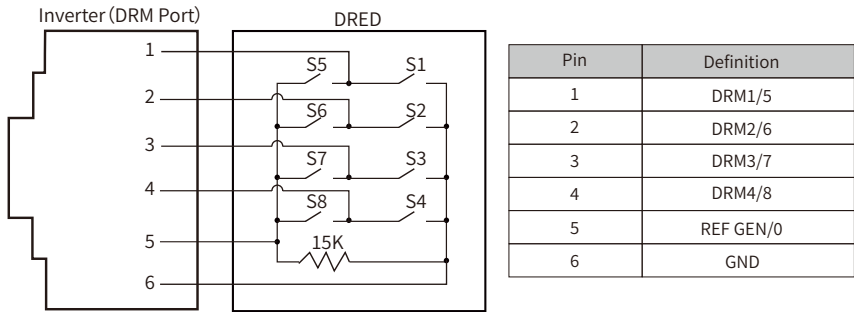

Pic 6.1

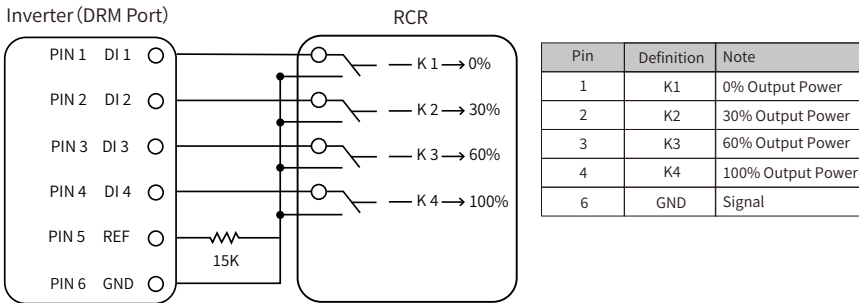

Pic 6.2

6.5 LCD night power supply(optional)

Add a PCB board which uses AC power to supply the LCD screen and data logger, and then the inverter can upload consumption power data to the cloud platform during night. This feature is optional.

7. Zero-export function via energy meter

When you are reading this, we believe that you have completed the connection according to the requirements of chapter 5, if you have been running your inverter at this time, and you want to use the zero-export function, please turn off AC and DC switch of the inverter, and wait for 5 minutes until the inverter completely discharged. Please follow below Pic 7.1 & Pic 7.18 to connect the energy meter.

For system wiring diagram, the red line refers to L line (L), the blue line refers to the neutral line (N), green line refers to ground wire (PE). Connecting energy meter RS485 cable to inverter's RS485 port. It's recommended to install an AC switch between the inverter and the utility grid, the specs of the AC switch are determined by the power of load.

The AC switch we recommend to connect to the inverter output can refer to Table 5.2. If there is no integrated DC switch inside the inverter you purchased, we commend you to connect the DC switch. The voltage and current of the switch depend on the PV array you access.

System connection diagram for the Eastron meter

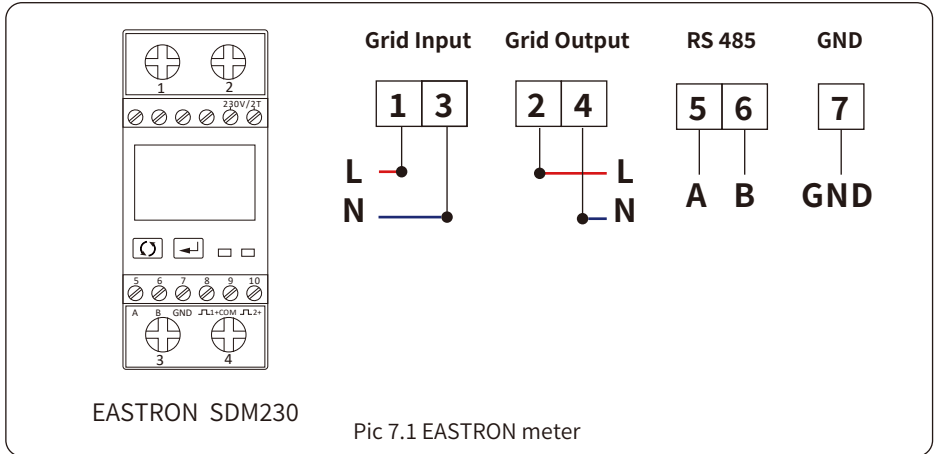

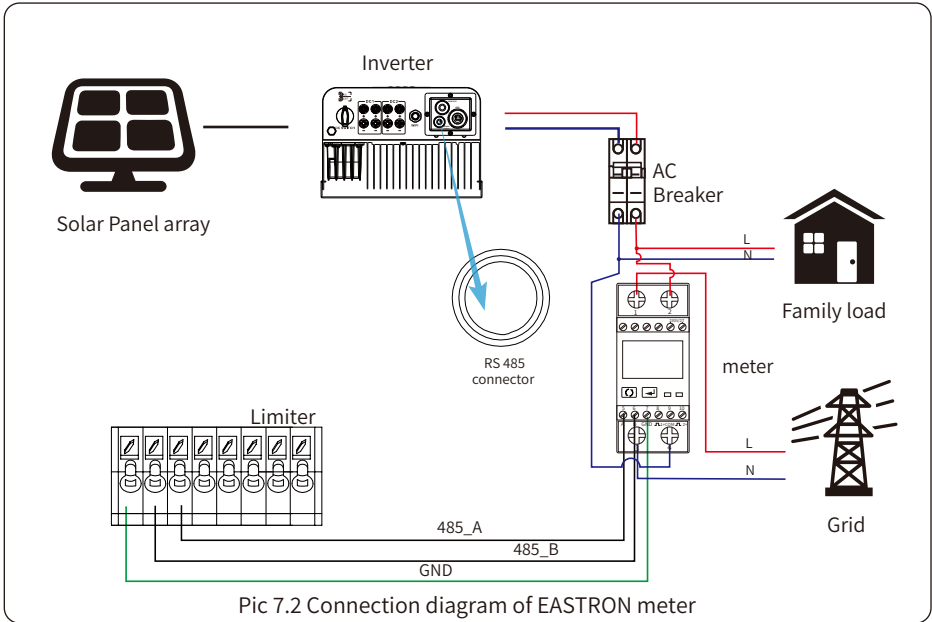

Pic 7.2 Connection diagram of EASTRON meter



Pic 7.3 Parameter setting

When the EASTRON meter connected successfully, it will shows SN: 2



Safety Hint:

Ensuring grid input cables connect 1&3 port of energy meter, and inverter AC output cables connect 2&4 port of energy meter when connecting.



Warning:

In final installation, breaker certified according to IEC 60947-1 and IEC 60947-2 shall be installed with the equipment.

System connection diagram for the CHNT meter

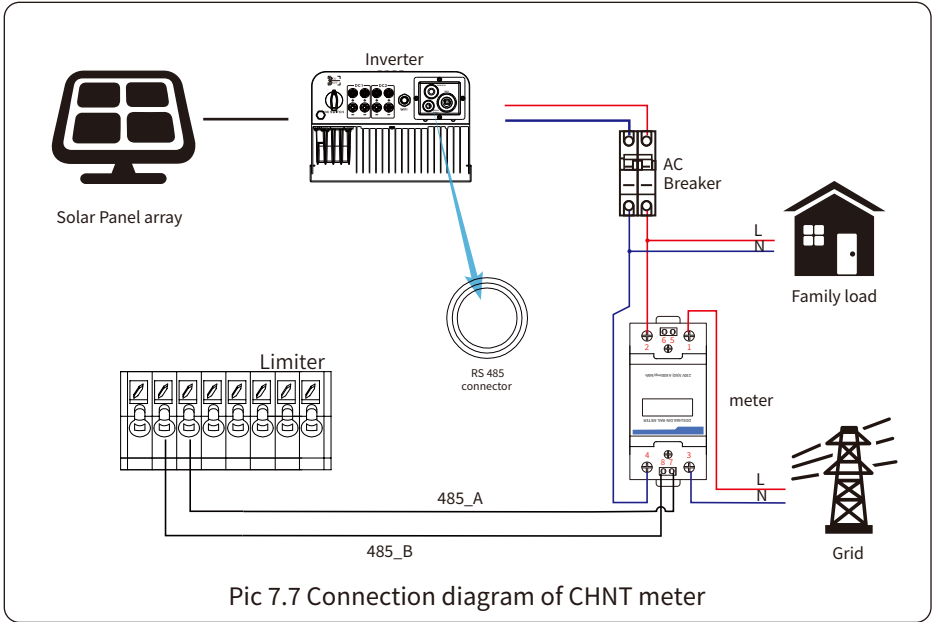
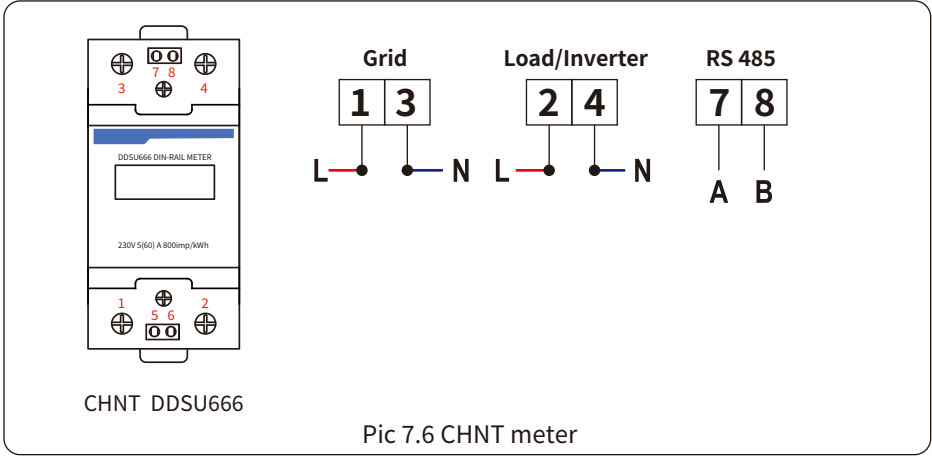

Pic 7.8 Parameter setting

When the CHNT meter connected successfully, it will shows SN: 1

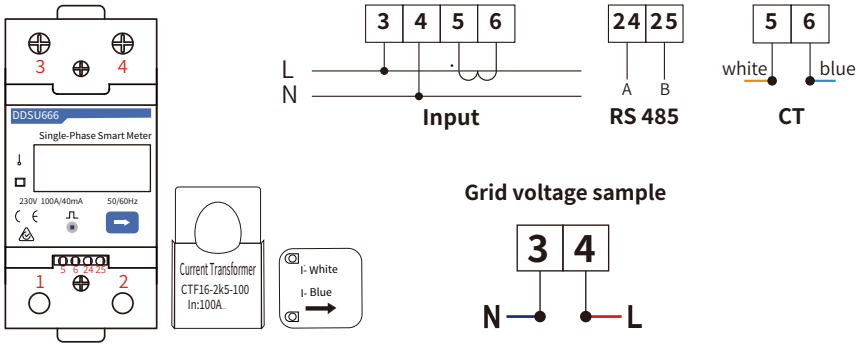

DDSU666-CT
(CTF16-2K5-100A)

Pic 7.9 CHNT meter

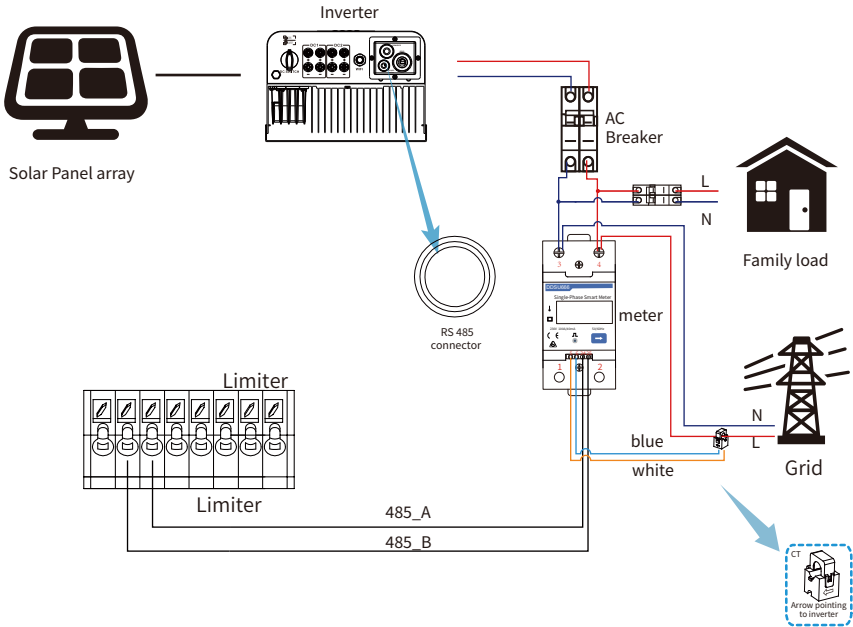

Pic 7.10 Connection diagram of CHNT meter

System connection diagram for the Eastron meter

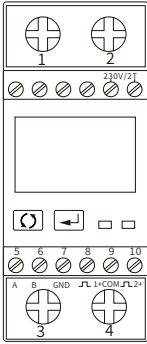

EASTRON SDM230

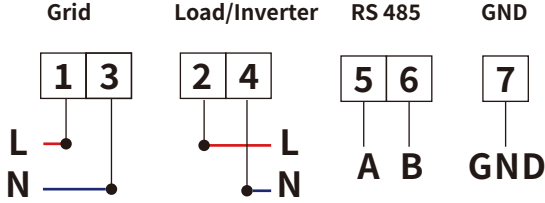

Pic 7.11 EASTRON meter

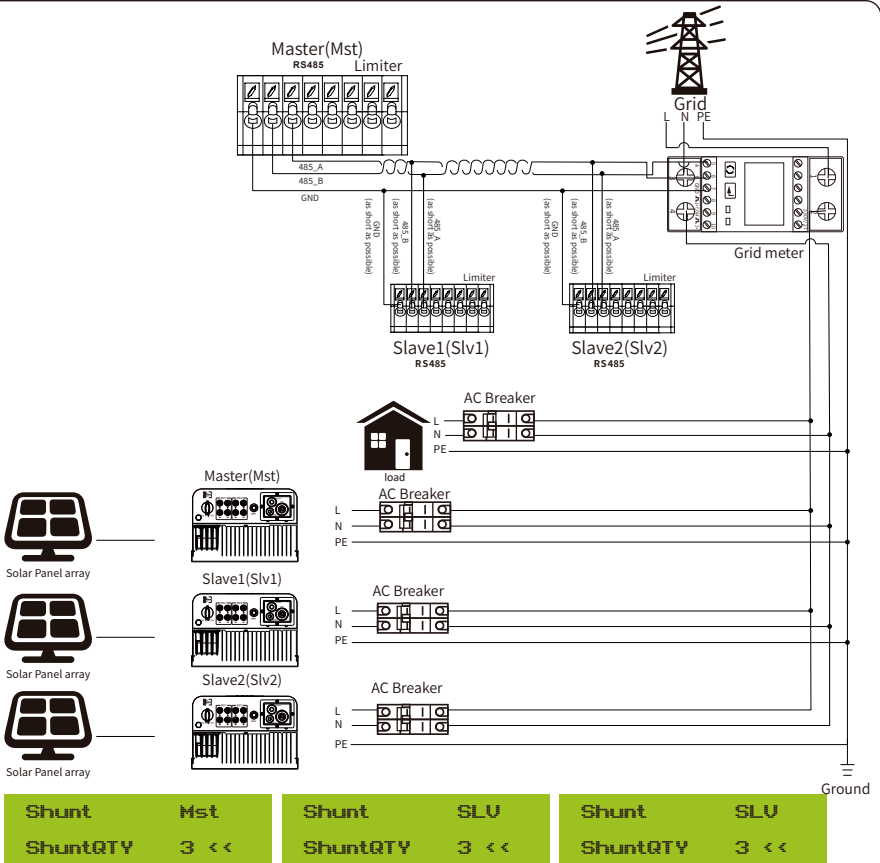

Pic 7.12 Eastron Connection diagram(The pass-through table)

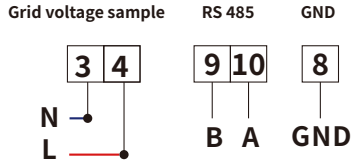
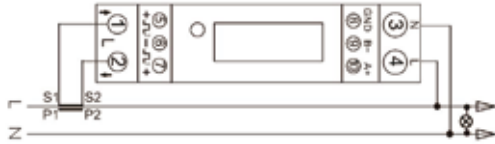
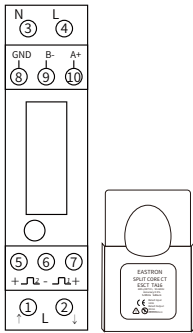

SDM120CTM-40mA
(ESCT-TA16 120A/40mA)

Pic 7.13 EASTRON meter

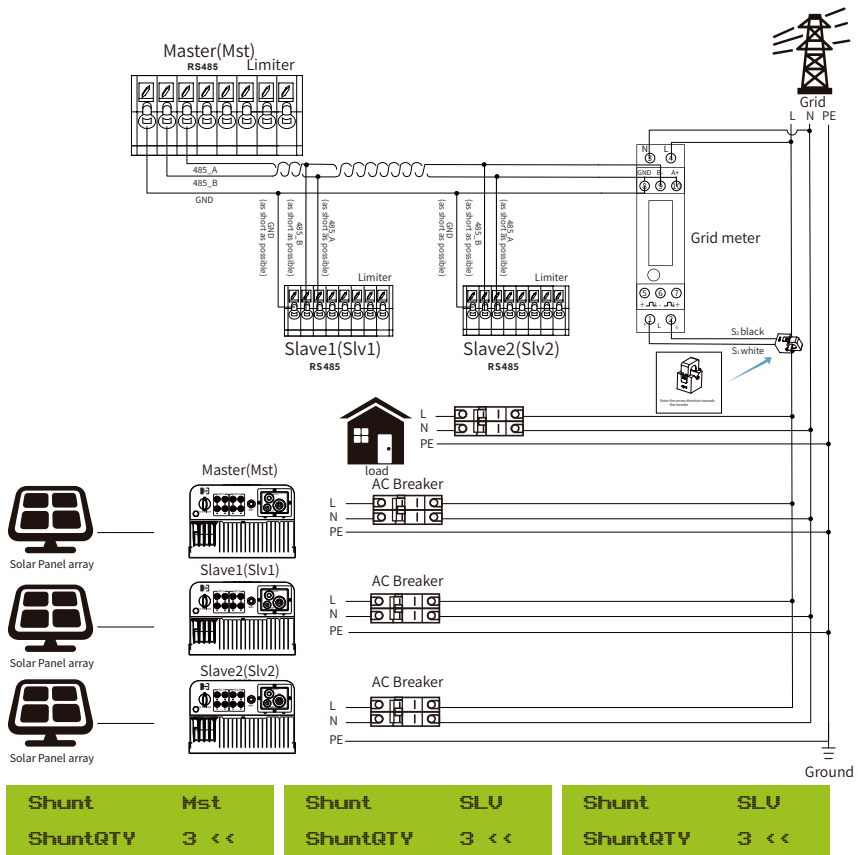

Pic 7.14 Eastron Connection diagram(The pass-through table)

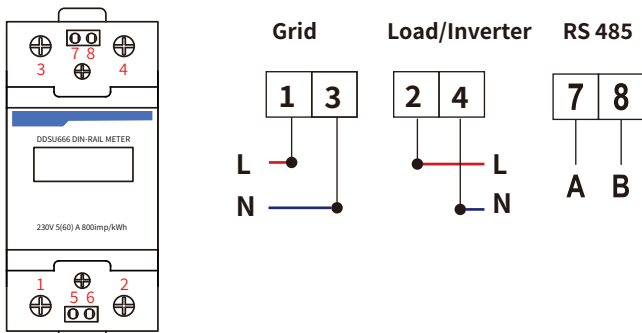

CHNT DDSU666

Pic 7.15 CHNT meter

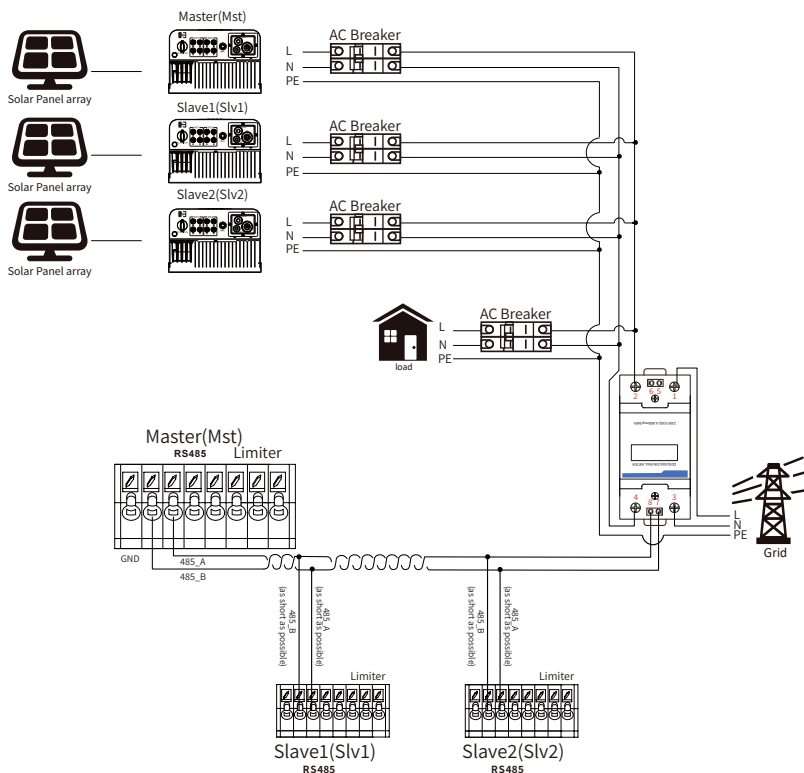

Shunt	Mst	Shunt	SLV	Shunt	SLV
ShuntQTY	3 <<	ShuntQTY	3 <<	ShuntQTY	3 <<

Pic 7.16 CHNT Connection diagram(The pass-through table)

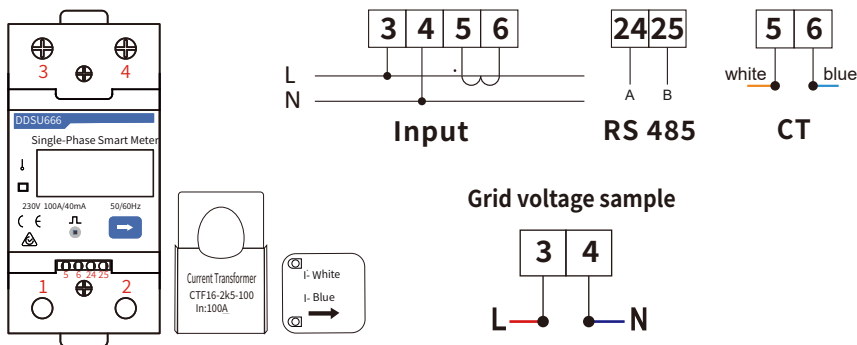

DDSU666-CT
(CTF16-2K5-100A)

Pic 7.17 CHNT meter

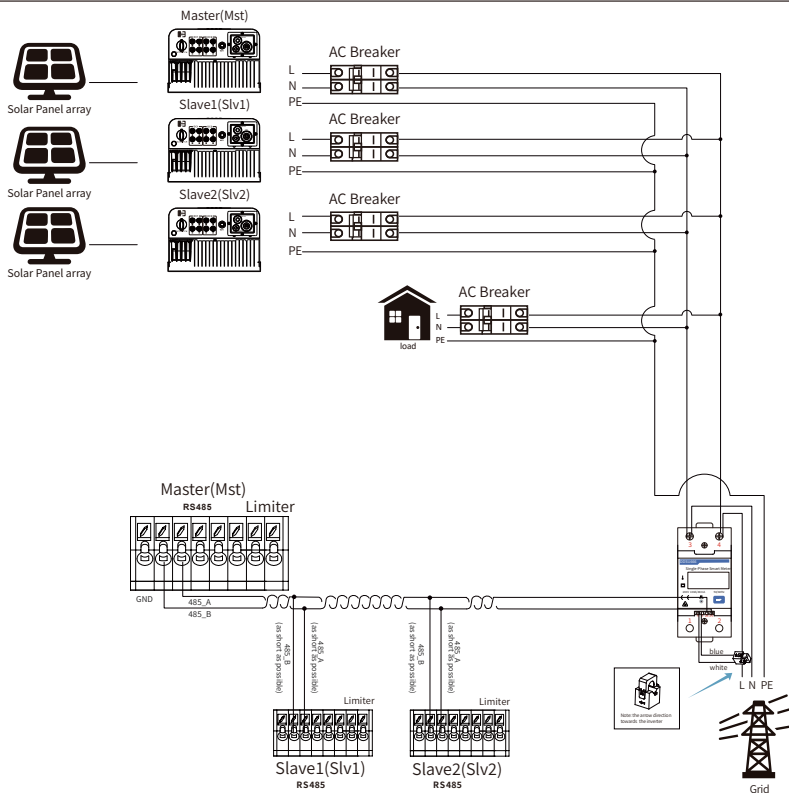

Shunt	Mst	Shunt	SLV	Shunt	SLV
ShuntRTY	3 <<	ShuntRTY	3 <<	ShuntRTY	3 <<

Pic 7.18 CHNT Connection diagram(The pass-through table)

7.1 Use of zero-export function

When the connection is completed, the following steps should be referred to use this function:

1. Turn on the AC switch.
2. Turn on the DC switch, waiting for the inverter's LCD is turned on.
3. Press Enter button on the LCD panel in the main interface into the menu options, select [parameter setting] to enter setup submenu, and then select [running parameters] as shown in picture 7.19, at this time please input the default password 1234 through pressing the button [up down, enter], enter the operation parameter setting interface, shown as picture 7.20.



Pic 7.19 Parameter setting



Pic 7.20 Meter switch

4. Operate the button [up down], move setting cursor to energy meter and press the button [enter]. At this time you can turn on or turn off the energy meter by choosing [up down] button, please press [enter] button to confirm when setting done.
5. Move the cursor to [OK], press [enter] to save the settings and exit the running parameters page, otherwise the settings are invalid.
6. If set up successfully, you can return to the menu interface, and display the LCD to [home page] by press the [up down] button. If it displays [meter power XXW], the zero-export function setting is completed. Shown as picture 7.21.



Pic 7.21 Zero-export function via energy meter turn on

7. Meter power XXW shows positive means grid is supplying the load, and no power fed into grid. if meter power shows negative, it means PV energy is being sold to grid.
8. After properly connection is done, wait for inverter starting. If the power of the PV array meets the current power consumption, the inverter will keep a certain output to counteract the power of the grid without backflow .

7.2 Sensor Clamp(optional)

The inverter has integrated export limitation function.The function is to adjust the output of inverter quickly according to the power of the user and solar panels, prevent the output of the inverter from being fed to the power grid. This limiter function is optional. If you buy the inverter with limiter, a current sensor will be included in the package which is necessary for limiter function.

7.2.1 Zero-export function via CT

When you are reading this, we believe that you have completed the connection according to the requirements of chapter 5, if you have been running your inverter at this time, and you want to use the limiter function, please turn off AC and DC switch of the inverter, and wait for 5 minutes until the inverter completely discharged. Then connect the current sensor to the inverter limiter interface. Make sure they are reliably connected, and the current sensor should clamp to the live wire of the incoming line. In order to make it easier for you to use the built-in limiter function of the inverter, we have specifically given the wiring diagram, as shown in Picture 7.23, the red lines connected to the utility grid said wire (L), blue line shows the zero line (N), yellow green line shows the ground wire (PE). We recommend installing a AC switch between the inverter outlet and the utility grid, the specs of the AC switch is determined according to the load capacity. The AC switch we recommend to connect to the inverter output can refer to Table 5.1. If there is no integrated DC switch inside the inverter you purchased, were commend you to connect the DC switch. The voltage and current of the switch depends on the PV array you access.

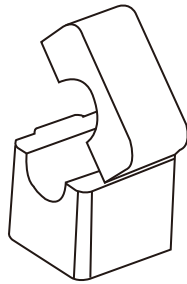

Pic 7.22 Sensor Clamp (The arrow of current sensor points to the grid)

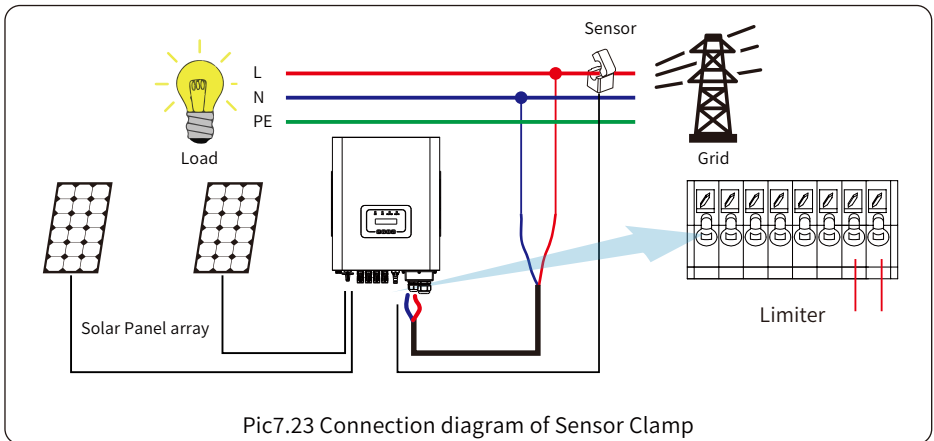

Pic7.23 Connection diagram of Sensor Clamp

7.3 Use of limiter function

When the connection is completed, the following steps should be referred to use this function:

1. Turn on the AC switch.
2. Turn on the DC switch, waiting for the inverter's LCD is turned on.
3. Press Enter button on the LCD panel in the main interface into the menu options, select [parameter setting] to enter setup submenu, and then select [running parameters] as shown in picture 7.24, at this time please input the default password 1234 through pressing the button [up down, enter], enter the operation parameter setting interface, shown as picture 7.25.



Pic 7.24 Parameter setting



Pic 7.25 Limit switch

4. Operate the button [up down], move setting cursor to limit function and press the button [enter]. At this time you can turn on or turn off the limit function by choosing [up down] button, please press [enter] button to confirm when setting done.
5. Move the cursor to [confirm] , press ENTER to save the settings and exit the running parameters page, otherwise the settings are invalid.
6. If set up successfully, you can return to the menu interface, and display the LCD to [home page] by press the [up down] button. If it displayed as [utility power], the limiter function settings will be completed. Shown as picture 7.26.



*** This item is not available for some FW verison**

Pic 7.26 Limiter function turn on

7. [utility power] showing positive means grid power is consuming energy, and there is no backflow. If [utility power] shows negative, which means there' s excess PV energy flows to grid or current transformer arrow direction is in wrong direction. Please read more on chapter 7.
8. After properly connection is done, wait for inverter starting. If the power of the PV array meets the current power consumption, the inverter will maintain a certain output to counteract the power of the grid without backflow .

7.4 Notes while using zero export function

For your safety and the operation of limiter function of the inverter, we put forward the following suggestions and precautions:



Safety Hint:

Under zero export mode we strongly recommend that the two PV arrays are formed by the same number of PV panels of the same size, which will make the inverter more responsive to limit the power.



Safety Hint:

While the utility power is negative and inverter has no output power, that means the orientation of the current sensor is wrong, please turn off the inverter and change orientation of the current sensor.

(when using limiter, the arrow of current sensor points to the grid)

7.5 How to browse the load power of your PV grid-tie plant on monitoring platform?

If you want to browse load power of the system and how much energy (KWH) does it export to grid (inverter output power is used to power the load firstly and then the surplus energy will feed into grid). You also need to connect the meter according to Pic 7.12. After the connection completed successfully, the inverter will show the load power on the LCD. **But please don't setup "Meter ON"**. Also, you will be able to browse the load power on the monitoring platform. The plant setting method as below description.

Firstly, go to the solarman platform (<https://pro.solarmanpv.com>, this link is for solarman distributor account; or <https://home.solarmanpv.com>, this link is for solarman end user account;) plant home page and click "edit"

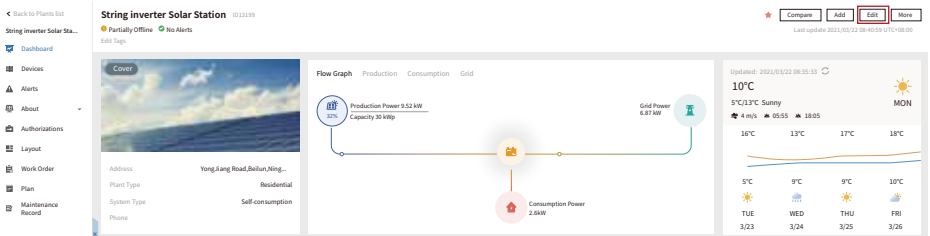

And then choose your system type as “Self-consumption”

Edit Plant

Basic Info
System Info
Yield Info
Owner Info

Address: Yong Liang Road, Bailun, NingBo, 315806, China

Coordinates: Longitude 121 46 19.03 Latitude 29 53 36.11

Time Zone: (UTC+08:00) Beijing,Chongqing,Hong Kong,Shanghai

Creation Time: 2020/4/28

System Info

Plant Type: Residential

System Type: **Self-consumption**

Capacity(kWp): 30

Address: 0-360

Secondly, go to plant page, if it shows the PV power, load power and grid power, which means the configuration is correct.

String inverter Solar Station 001009

Partially Offline No Alerts

Compare Add Edit More

Last update 2021/03/22 08:40:28 UTC+08:00

Dashboard

Devices

Alerts

About

Authorizations

Layout

Work Order

Plan

Maintenance Record

Address: Yong Liang Road, Bailun, Ning...

Plant Type: Residential

System Type: Self-consumption

Phone:

Flow Graph Production Consumption Grid

Production Power 9.52 kW
Capacity 30 kWp

Grid Power 6.87 kW

Consumption Power 2.6kW

10°C
5°C 13°C Sunny
4h 95.55 18:05 MON

16°C 11°C 17°C 18°C

9°C 9°C 9°C 10°C
TUE WED THU FRI
3/23 3/24 3/25 3/26

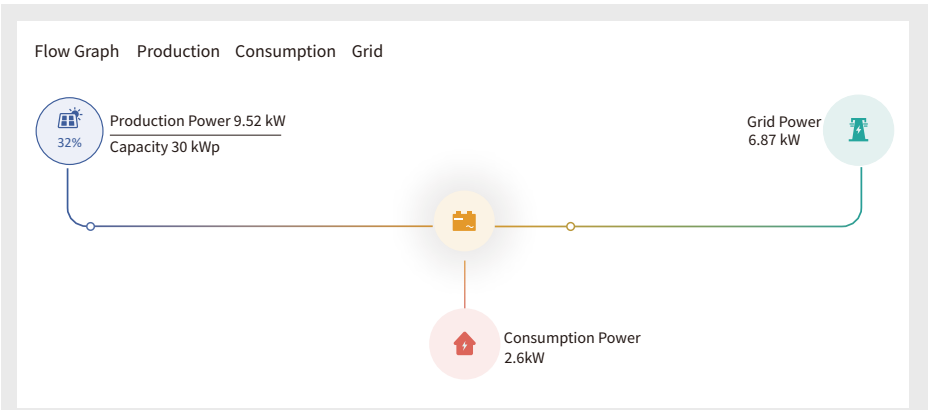

8. General Operation

During normal operation, the LCD shows the current status of the inverter, including the current power, total generation, a bar chart of power operation and inverter ID, etc. Press the Up key and the Down key to see the current DC voltage, DC current, AC voltage, AC current, inverter radiator temperature, software version number and Wifi connection state of the inverter.

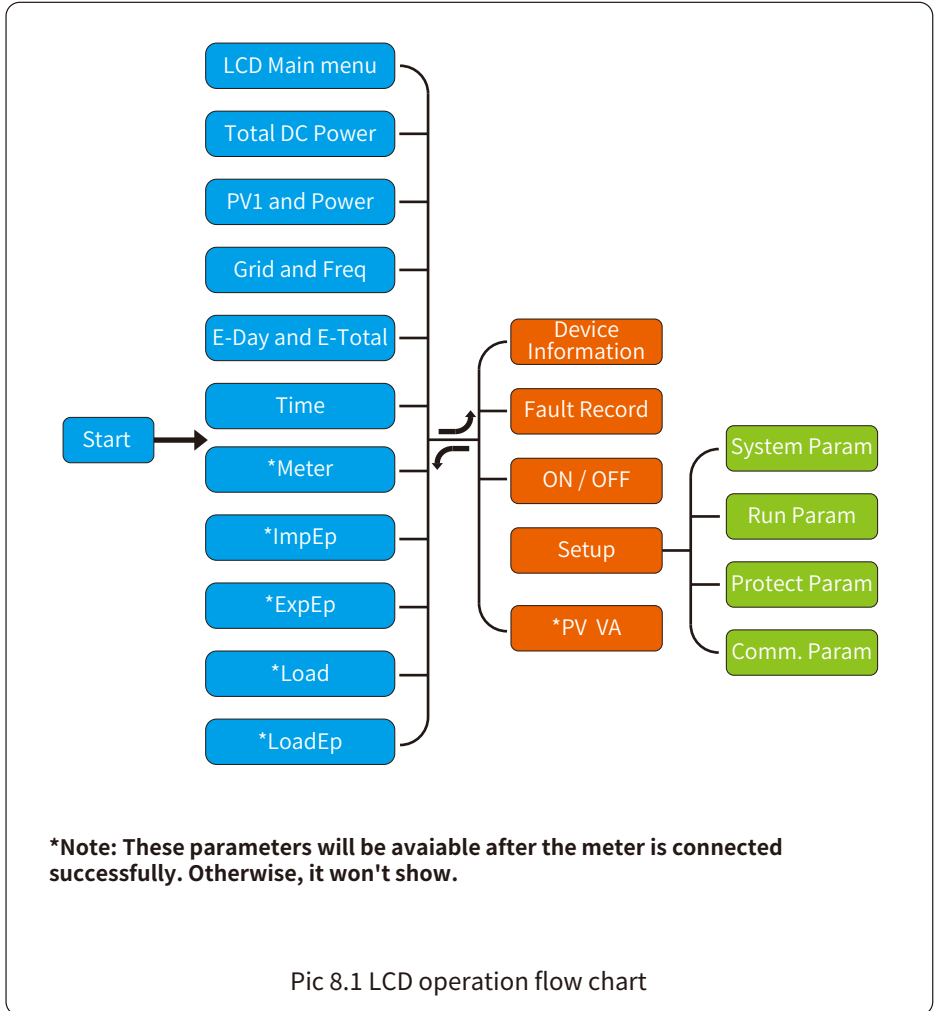

Pic 8.1 LCD operation flow chart

8.1 The initial interface

From the initial interface, you can check PV power, PV voltage, grid voltage, inverter ID, model and other information.



Pic 8.2 The initial interface

Press UP or Down, you can check inverter DC voltage, DC current, AC voltage, AC current and inverter radiator temperature(Temperature can only be seen by long pressing the button [ESC]. [enter]).



Pic 8.3 PV input voltage and current information



Pic 8.4 AC running state information

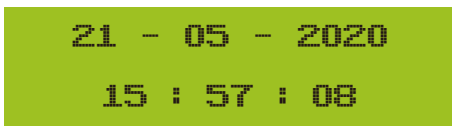

Pic 8.5 Time



Pic 8.6 Meter power

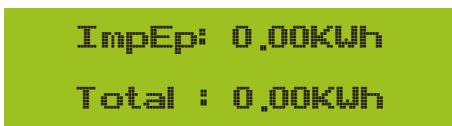

Pic 8.7 Electrical energy

ImpEp: Daily energy purchased from grid;
Total: Total energy purchased from grid.

ExpEp: 0,00KWh
Total : 0,00KWh

ExpEp: Daily energy sold to grid;
Total: Total energy sold to grid.

Pic 8.8 Electrical energy

Load
Power: 0W

Pic 8.9 Load power

LoadEp: 0,00KWh
Total : 0,00KWh

LoadEp: Daily consumption;
Total: Total energy consumption.

Pic 8.10 Load consumption

E-Day : 0Wh
E-Total : 134KWh

E-Day: Daily generation;
E-Total: Total generation.

Pic 8.11 PV generation

8.2 Submenus in the Main Menu

There are five submenus in the Main Menu.

8.2.1 Device information

Device Info, <<
Fault Record

GL3000 SN-01
PF:0,000

ID:2222224332
Inv1400

Inv1400
Lcd0238

Pic 8.12 Device information

You can see the LCD software Lcd0238 and Control Software Version Inv1400. In this interface, there are parameters such as rated power communication addresses.

8.2.2 Fault Record

It can keep eight fault records in the menu including time, customer can deal with it depends on the error code.



Pic 8.13 Fault Record

8.2.3 ON/OFF setting

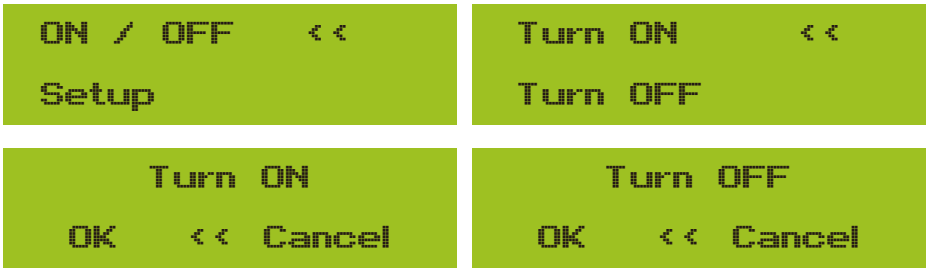

Pic 8.14 ON/OFF setting

When "Turn OFF" is selected and press "OK" to be checked, it will stop working immediately. And, it will be in Off status. When the "turn on" is ticked again, it will go to self-test program again. If it passed the selfcheck, it will start to work again.

8.2.4 Parameter setting

There are four submenus in the setup. Setting includes system param, run param, protect param, comm.param. All of these information for maintenance reference.

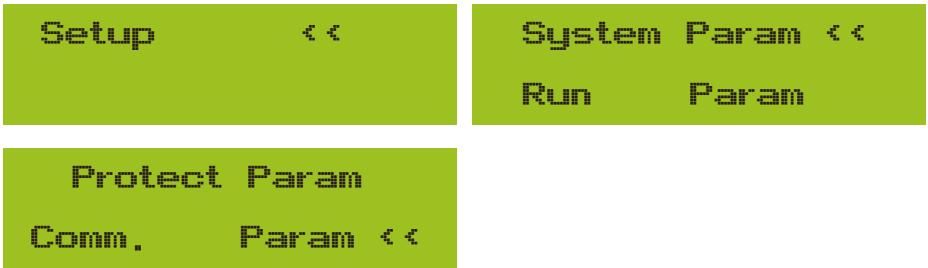

Pic 8.15 Submenus of the parameter setup

8.3 System param setting

System Param includes time set, language set, display set and factory reset.



Pic 8.16 System Param



20200522 OK
08:11:21 Cancel

Pic 8.17 Time



English <<
Polski



P CCK <<
Nederland

Pic 8.18 Language



Bright Kepp <<
Delay time 05S

Pic 8.19 LCD Screen settings



Delay time 05S
OK << Cancel

Pic 8.20 Delay time set



Confirm Reset <<
Cancel

Pic 8.21 Reset to factory setting



I Confirm <<
Cancel

Pic 8.22 Set Restore

8.4 Running param setting



Warning:

Password required-- only for access-authorized engineer. Un-authorized access may avoid the warranty. The initial password is 1234.



Warning:

The "--" symbol at the bottom right corner indicates that the machine does not have this function.



PassWord

* * * *

Pic 8.23 Password

8.4.1 ActiveP setting



ActiveP: Adjust the output active power in %

Pic 8.24



ReactiveP: Adjust reactive power output in %

Pic 8.25



PF: Power Factor

Fun_ISO: Insulation resistance detection

Pic 8.26



Fun_RCD: Residual current detection

Self-check: Inverter's self-check time. The default value 60s

Pic 8.27



Island: Anti-islanding protection

Meter: Energy meter. If inverter will connect meter, then set here to ON

Pic 8.28

```
Exp_Mode      AUG
CT_Ratio      1 <<
```

```
Exp_Mode      MIN
CT_Ratio      1 <<
```

```
MFR           AUTO<-
Back          <<
```

```
MFR           ACREL<-
Back          <<
```

```
MFR           EASTRON<-
Back          <<
```

```
MFR           CHNT<-
Back          <<
```

Pic 8.29 Meter

```
Limiter       ON <<
Feed-in       0%
```

Feed_In %: it is used to deploy how much power can be feed into grid.
For example, Feed_in=50% of the 6W model, which means Max. 3KW power can be feed into grid.And, this parameter is valid only after connecting a meter and the meter function is "ON".

```
MPPT_Num     0
WindTurbine   <<
```

Pic 8.30

```
V1:  0.0V <-
      0.0A
```

```
V2:  0.0V <-
      0.0A
```

```
V3:  0.0V <-
      0.0A
```

```
V4:  0.0V <-
      0.0A
```

```
V5:  0.0V <-
      0.0A
```

```
V6:  0.0V <-
      0.0A
```

```
V7:  0.0V <-
      0.0A
```

```
V8:  0.0V <-
      0.0A
```

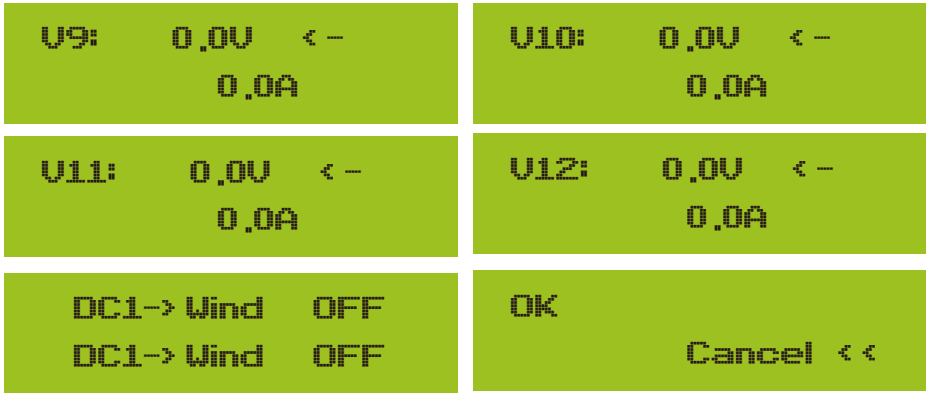

Pic 8.31 WindTurbine



Pic 8.32 Arc-Fault Detection

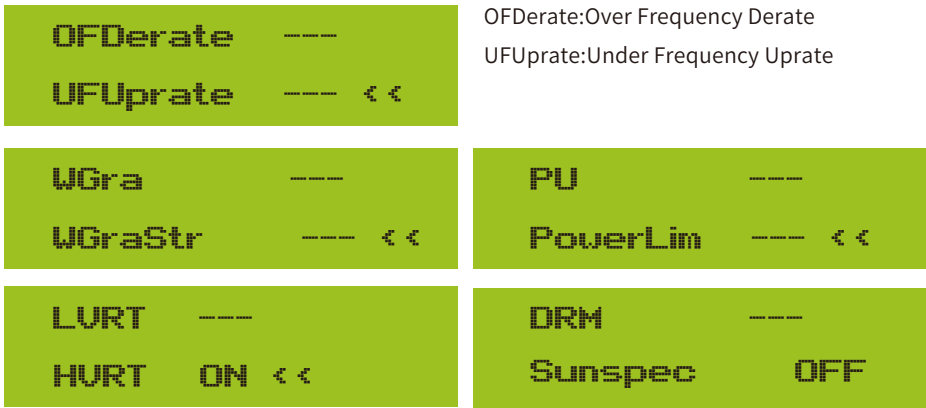

Pic 8.33 active power droop



8.5 Protect Param setting



Warning:

Engineer Only.

We will set the param depends on the safety requirements, so customers don't need to reset it. The password is same as 8.4 Running param



Pic 8.34 Password

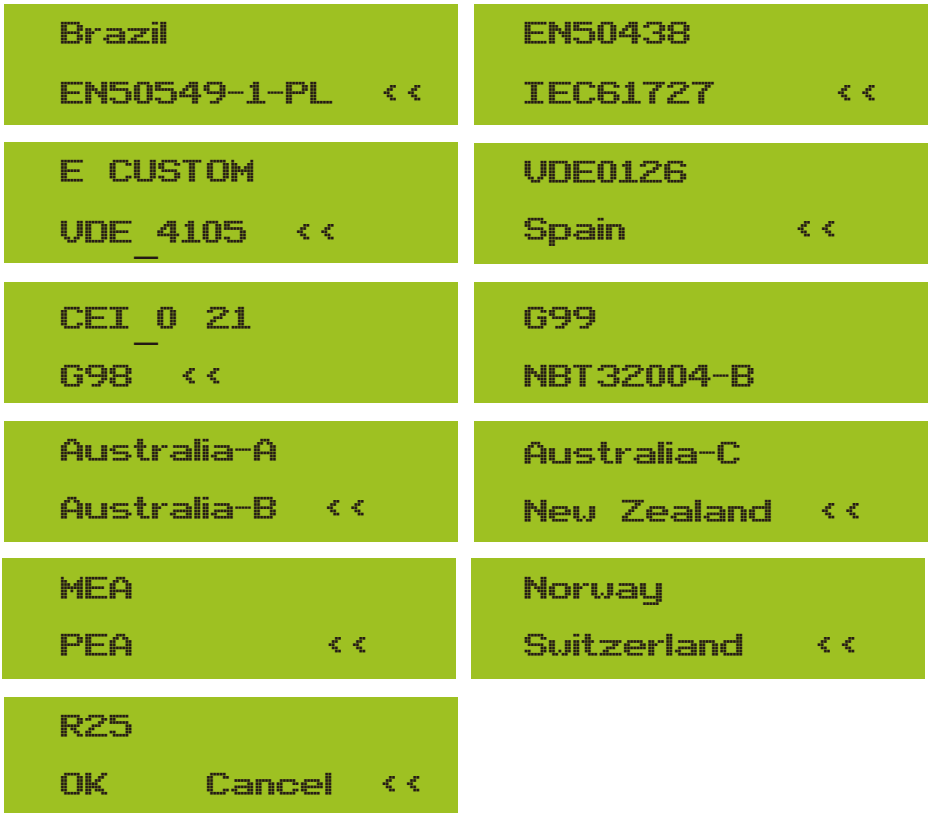

Pic 8.35 GirdStandarder

OverVolt Lv3 Point 240,00V <<	OverVolt Lv3 Delay 1000ms <<
OverVolt Lv2 Point 240,00V <<	OverVolt Lv2 Delay 1000ms <<
OverVolt Lv1 Point 240,00V <<	OverVolt Lv1 Delay 1000ms <<
UnderVolt Lv1 Point 235,00V <<	UnderVolt Lv1 Delay 1000ms <<
UnderVolt Lv2 Point 235,00V <<	UnderVolt Lv2 Delay 1000ms <<
UnderVolt Lv3 Point 235,00V <<	UnderVolt Lv3 Delay 1000ms <<
OverFreq Lv3 Point 52,00Hz <<	OverFreq Lv3 Delay 1000ms <<
OverFreq Lv2 Point 52,00Hz <<	OverFreq Lv2 Delay 1000ms <<
OverFreq Lv1 Point 52,00Hz <<	OverFreq Lv1 Delay 1000ms <<
UnderFreq Lv1 Point 48,00Hz <<	UnderFreq Lv1 Delay 1000ms <<

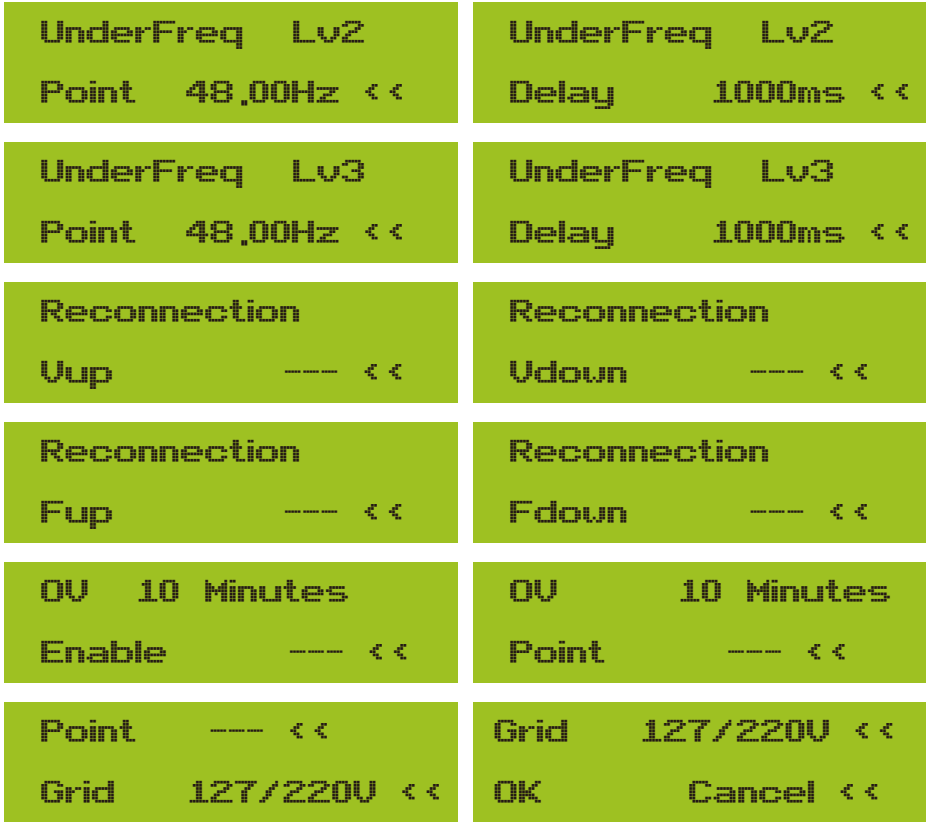

Pic 8.36 Advanced

8.6 Comm. param setting



Pic 8.37 Data Logger Modbus Address



Pic 8.38 The currently detected meter



Warning:
Engineer only.

9. Repair and Maintenance

String type inverter doesn't need regular maintenance. However, debris or dust will affect heat sink's thermal performance. It is better to clean it with a soft brush. If the surface is too dirty and affect the reading of LCD and LED lamp, you can use wet cloth to clean it up.



High Temperature Hazard:

When the device is running, the local temperature is too high and the touch can cause burns. Turn off the inverter and wait for it cooling, then you can clean and maintain.



Safety Hint:

No solvent, abrasive materials or corrosive materials can be used for cleaning any parts of the inverter.

10. Error information and processing

Inverter has been designed in accordance with international grid tied standards for safety, and electromagnetic compatibility requirements. Before delivering to the customer the inverter has been subjected to several tests to ensure its optimal operation and reliability.

10.1 Error code

If there is any failure, the LCD screen will display an alarm message. In this case, the inverter may stop feeding energy into the grid. The alarm description and their corresponding alarm messages are listed in Table 10.1.

Error code	Description	Ongrid - Single Phase
F01	DC input polarity reverse fault	Check the PV input polarity.
F02	DC insulation impedance permanent fault	Check the grounding cable of inverter.
F03	DC leakage current fault	Hardly appear the code. Never ever happened so far.
F04	Ground fault GFDI	Check the solar panel output connection.
F05	Read the memory error	Failure in reading memory (EEPROM). Restart the inverter if the fault still exists, contact your installer or Deye service.
F06	Write the memory error	Failure in writing memory (EEPROM). Restart the inverter if the fault still exists, contact your installer or Deye service.
F07	GFDI blown fuse	Hardly appear the code. Never ever happened so far.
F08	GFDI grounding touch failure	Hardly appear the code. Never ever happened so far.
F09	IGBT damaged by excessive drop voltage	Hardly appear the code. Never ever happened so far.

Error code	Description	Ongrid - Single Phase
F10	Auxiliary switch power supply failure	Hardly appear the code. Never ever happened so far.
F11	Ac main contactor errors	Hardly appear the code. Never ever happened so far.
F12	AC auxiliary contactor errors	Hardly appear the code. Never ever happened so far.
F13	Working mode changed/Grid mode changed	Hardly appear the code. Never ever happened so far.
F14	DC firmware over current	Hardly appear the code. Never ever happened so far.
F15	AC firmware over current	<ol style="list-style-type: none"> 1. The internal AC sensor or detection circuit on control board or connection wire may loose. 2. Restart the inverter, if the error still exists, please contact your installer or Deye service.
F16	GFCI(RCD) Ac leakage current fault	<ol style="list-style-type: none"> 1. This fault means the average leakage current is over 300mA. Check whether DC power supply or solar panels is ok, then check 'Test data'-> 'diL' value is about 120; Then check the leakage current sensor or circuit(the following picture). Checking test data needs using big LCD. 2. Restart the inverter, if the error still exists, please contact your installer or Deye service.
F17	Three phase current, over-current fault	Hardly appear the code. Never ever happened so far.
F18	AC over current fault of hardware	<ol style="list-style-type: none"> 1. Check AC sensor or detection circuit on control board or connection wire. 2. Restart the inverter or factory reset, if the error still exists, please contact your installer or Deye service.
F19	All hardware failure synthesis	<ol style="list-style-type: none"> 1. When inverter is running, wifi plug plugin, will occur F19. 2. Restart the inverter or factory reset, if the error still exists, please contact your installer or Deye service.
F20	DC over current fault of the hardware	Not available.
F21	DC leakage flow fault	Hardly appear the code. Never ever happened so far.
F22	Crash stop (if there is a stop button)	Contact your installer for help.
F23	AC leakage current is transient over current	<ol style="list-style-type: none"> 1. This fault means the leakage current is above 30mA suddenly. Check whether DC power supply or solar panels is ok, then check 'Test data'-> 'diL' value is about 120; Then check the leakage current sensor or circuit. Check test data needs using big LCD. 2. Restart the inverter, if the fault still exists, contact your installer or Deye service.
F24	DC insulation impedance failure	<ol style="list-style-type: none"> 1. Check Vpe resistance on main board or detection on control board. Check PV panels is OK. Many times this issue is the PV problem. 2. Check whether the PV panel (aluminum frame) is grounded well and inverter is grounded well. Open the cover of inverter and then check the inside ground cable is fixed well on the shell. 3. Check if the AC/DC cable, terminal block are shorted to ground or the insulation is damaged. 4. Restart the inverter, if the fault still exists, contact your installer or Deye service.
F25	DC feedback fault	Hardly appear the code. Never ever happened so far.
F26	The DC busbar is unbalanced	Hardly appear the code. Never ever happened so far.

Error code	Description	Ongrid - Single Phase
F27	DC end insulation error	Hardly appear the code. Never ever happened so far.
F28	Inverter 1 DC high fault	Hardly appear the code. Never ever happened so far.
F29	AC load switch failure	Hardly appear the code. Never ever happened so far.
F30	AC main contactor failure	<ol style="list-style-type: none"> 1. Check relays and AC voltage of relays. 2. Check relays driver circuit. 3. Check if the software is not suitable for this inverter. (Old inverter not have relays detection function) 4. restart the inverter, if the fault still exists, contact your installer or Deye service.
F31	Dc boost soft start	Not available.
F32	Inverter 2 dc high fault	Hardly appear the code. Never ever happened so far.
F33	AC over current	AC current sensor or its circuit have issue. Check if the inverter type is not right.
F34	AC current over load	Hardly appear the code. Never ever happened so far.
F35	No AC grid	<ol style="list-style-type: none"> 1. Check AC grid voltage. Check AC voltage detection circuit. Check if the AC connector in good condition. Check whether the AC grid is normal in voltage. 2. Restart the inverter, if the fault still exists, contact your installer or Deye service.
F36	AC grid phase error	Hardly appear the code. Never ever happened so far.
F37	AC three-phase voltage unbalance failure	Hardly appear the code. Never ever happened so far.
F38	AC three-phase current unbalance failure	Hardly appear the code. Never ever happened so far.
F39	AC over current(one cycle)	<ol style="list-style-type: none"> 1. Check AC current sensor and its circuit. 2. Restart the inverter, if the fault still exists, contact your installer or Deye service.
F40	DC over current	Hardly appear the code. Never ever happened so far.
F41	AC Line W,U over voltage	Check the AC voltage protection setting. And Check if the AC cable is too thin.Check the voltage difference between LCD and meter.
F42	AC Line W,U low voltage	Check the AC voltage protection setting. Check the voltage difference between LCD and meter. Also need to check whether AC cables are all firmly and correctly connected.
F43	AC Line V,W over voltage	Not available.
F44	AC Line V,W low voltage	Not available.
F45	AC Line U,V over voltage	Not available.
F46	AC Line U,V low voltage	Not available.
F47	AC Over frequency	Check the frequency protection setting.
F48	AC lower frequency	Check the frequency protection setting.
F49	U phase grid current DC component over current	Hardly appear the code. Never ever happened so far.
F50	V phase grid current DC component over current	Hardly appear the code. Never ever happened so far.

Error code	Description	Ongrid - Single Phase
F51	W phase grid current DC component over current	Hardly appear the code. Never ever happened so far.
F52	AC inductor A, phase current DC current high	Hardly appear the code. Never ever happened so far.
F53	AC inductor B, phase current DC current high	Hardly appear the code. Never ever happened so far.
F54	AC inductor C, phase current DC current high	Hardly appear the code. Never ever happened so far.
F55	DC busbar voltage is too high	1. Check PV voltage and Ubus voltage and its detection circuit. If the PV input voltage exceeds the limit, please reduce the number of solar panels in series. 2. For Ubus voltage, please check the LCD display.
F56	DC busbar voltage is too low	1. It tells the PV input voltage is low and it always happens in the early morning. 2. Check PV voltage and Ubus voltage. When inverter is running, then showing F56, maybe Loss of driver or need update firmware. 3. Restart the inverter, if the fault still exists, contact your installer or Deye service.
F57	AC reverse irrigation	AC reverse irrigation.
F58	AC grid U over current	Hardly appear the code. Never ever happened so far.
F59	AC grid V over current	Hardly appear the code. Never ever happened so far.
F60	AC grid W over current	Hardly appear the code. Never ever happened so far.
F61	Reactor A phase over current	Hardly appear the code. Never ever happened so far.
F62	Reactor B phase over current	Hardly appear the code. Never ever happened so far.
F63	ARC fault	1. Check PV module cable connection and clear the fault; 2. Seek help from us, if can not go back to normal state.
F64	IGBT heat sink high temperature	1. Check temperature sensor. Check if firmware is suitable for the hardware. Check if the inverter is its right model. 2. Restart the inverter, if the fault still exists, contact your installer or Deye service.

Table10.1 Error codes and their solutions



Safety Hint:

If your string inverter has any of the fault information shown in Table 10-1, and when you reset the machine and still don't solve the problem, please contact our distributor and provide the below details:

1. Serial number of the inverter;
2. The distributor/dealer of the inverter(if available);
3. Installation date;
4. The discription of problem(include LCD'error code and LED starus indicator lights);
5. Your contact details.

11.Specification

Model	SUN-9K- G02P1-EU-CM2	SUN-10K- G02P1-EU-CM2	SUN-10.5K- G02P1-EU-CM2
PV String Input Data			
Max. PV Input Power(kW)	13.5	15	15.8
Max. PV Input Voltage(V)		550	
Start-up Voltage(V)		80	
PV Input Voltage Range(V)		80-550	
MPPT Voltage Range(V)		70-500	
Rated PV Input Voltage(V)		360	
Full Load MPPT Voltage Range(V)	225-500	250-500	265-500
Max. Input Short Circuit Current (A)		39+39	
Max. Operating PV Input Current(A)		26+26	
No. of MPP Trackers/No. of Strings MPP Tracker		2/2+2	
Max. Inverter Backfeed Current To the Array		0	
AC Output Data			
Rated AC Output Active Power(kW)	9	10	10.5
Max. AC Output Apparent Power(kVA)	9.9	11	11.55
Rated AC Output current (A)	41/39.2	45.5/43.5	47.8/45.7
Max. AC Output Current(A)	45/43.1	50/47.9	52.5/50.3
Max. Output Fault Current(A)	78.4	87	91.4
Max. Output Overcurrent Protection(A)		110	
Rated Output voltage/range (V)		220/230V	0.85Un-1.1Un
Grid Connection Form		L+N+PE	
Rated Output Grid Frequency/range(Hz)		50Hz/45Hz-55Hz, 60Hz/55Hz-65Hz	
Power Factor Adjustment Range		0.8 leading-0.8lagging	
Total Current Harmonic Distortion THDi		<3%	
DC Injection Current		<0.5%In	
Efficiency			
Max.Efficiency		97.7%	
Euro Efficiency		97.2%	
MPPT Efficiency		>99%	
Equipment Protection			
DC Polarity Reverse Connection Protection		yes	
AC Output Overcurrent Protection		yes	
AC Output Overvoltage Protection		yes	
AC Output Short Circuit Protection		yes	
Thermal Protection		yes	
DC Terminal Insulation Impedance Monitoring		yes	
DC component monitoring		yes	
Ground fault current monitoring		yes	
Arc fault circuit interrupter (AFCI)		Optional	
Power Network Monitoring		yes	
Island protection monitoring		yes	
Earth Fault Detection		yes	
DC Input Switch		yes	
Overvoltage Load Drop Protection		yes	
Residual Current (RCD) Detection		yes	
Surge Protection Level		TYPE II(DC),TYPE II(AC)	

Interface	
Communication Interface	RS485
Monitor Mode	GPRS/Bluetooth/4G/WIFI
Display	LCD+LED
General Data	
Operating Temperature Range (°C)	-25 to +60°C, >45°C derating
Permissible Ambient Humidity	0-100%
Permissible Altitude (m)	3000m
Noise (dB)	≤ 35dB
Ingress Protection(IP) Rating	IP 65
Inverter Topology	Non-Isolated
Over Voltage Category	OVC II(DC),OVC III(AC)
Cabinet Size (W*H*D) [mm]	330×410×213.5 (Excluding connectors and brackets)
Weight [kg]	14.8
Warranty [year]	Standard 5 years, extended warranty
Type Of Cooling	Natural cooling
Grid Regulation	IEC 61727, IEC 62116, EN 50549, NRS 097, RD 140, UNE 217002, G99
Safety EMC/Standard	IEC/EN 61000-6-1/2/3/4, IEC/EN 62109-1, IEC/EN 62109-2

12. EU Declaration of Conformity



within the scope of the EU directives

- Radio Equipment Directive (RED) 2014/53/EU.
- Restriction of the use of certain hazardous substances 2011/65/EU(RoHS)

NINGBO DEYE INVERTER TECHNOLOGY CO., LTD. confirms herewith that the products described in this document are in compliance with the fundamental requirements and other relevant provisions of the above mentioned directives. The entire EU Declaration of Conformity and certificate can be found at <https://www.deyeinverter.com/download/#string-inverter>.

EU Declaration of Conformity

Product: **PV Inverter**

Models: SUN-7K-G02P1-EU-CM2; SUN-7.5K-G02P1-EU-CM2; SUN-8K-G02P1-EU-CM2; SUN-9K-G02P1-EU-CM2;
SUN-10K-G02P1-EU-CM2; SUN-10.5K-G02P1-EU-CM2;

Name and address of the manufacturer: Ningbo Deye Inverter Technology Co., Ltd.
No. 26 South YongJiang Road, Daqi, Beilun, NingBo, China

This declaration of conformity is issued under the sole responsibility of the manufacturer. Also this product is under manufacturer's warranty.

This declaration of conformity is not valid any longer: if the product is modified, supplemented or changed in any other way, as well as in case the product is used or installed improperly.

The object of the declaration described above is in conformity with the relevant Union harmonization legislation:

- Radio Equipment Directive (RED) 2014/53/EU.
- Restriction of the use of certain Hazardous Substances (RoHS) Directive 2011/65/EU and 2015/863/EU



References to the relevant harmonized standards used or references to the other technical specifications in relation to which conformity is declared:

Health and Safety (RED, Article 3.1a)	
EN IEC 62311:2020	●
EN 62109-1:2010	●
EN 62109-2:2011	●
EMC (RED, Article 3.1b)	
EN IEC 61000-6-1:2019	●
EN IEC 61000-6-2:2019	●
EN IEC 61000-6-3:2021	●
EN IEC 61000-6-4:2019	●
EN 301489-1 V2.2.3:2019	●
EN 301489-17 V 3.2.4:2020	●
EN 55011:2016+A1+A11+A2	●
EN 61000-3-3:2013+A1	●
EN 62920:2017+A11+A1	●
EN IEC 61000-3-2:2019	●
CISPR 11:2015+A1+A2	●
Radio Aspects (RED, Article 3.2)	
EN 300328 V2.2.2:2019	●

Cybersecurity (RED, Article 3.3)	
EN 18031-1:2024	●
RoHS	
EN IEC 63000:2018	●

Additional information: CE mark was affixed on the product since 2025.

Nom et Titre / Name and Title:

Bard Dai
Senior Standard and Certification Engineer
宁波德业变频技术有限公司

Au nom de / On behalf of:

Ningbo Deye Inverter Technology Co., Ltd.

Date / Date (yyyy-mm-dd):

2025-10-20

A / Place:

Ningbo, China

NINGBO DEYE INVERTER TECHNOLOGY CO., LTD.

Add. : No.26 South YongJiang Road, Daqi, Beilun, NingBo, China.

Tel. : +86 (0) 574 8622 8957

Fax. : +86 (0) 574 8622 8852

E-mail : service@deye.com.cn

Web. : www.deyeinverter.com